



SpaceX Starship SN-8

Print on metallic paper
on its white side



1:100 Scale

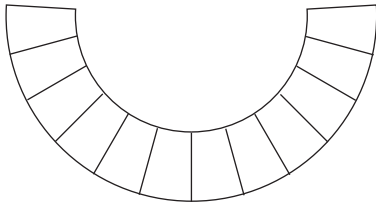

ring 7

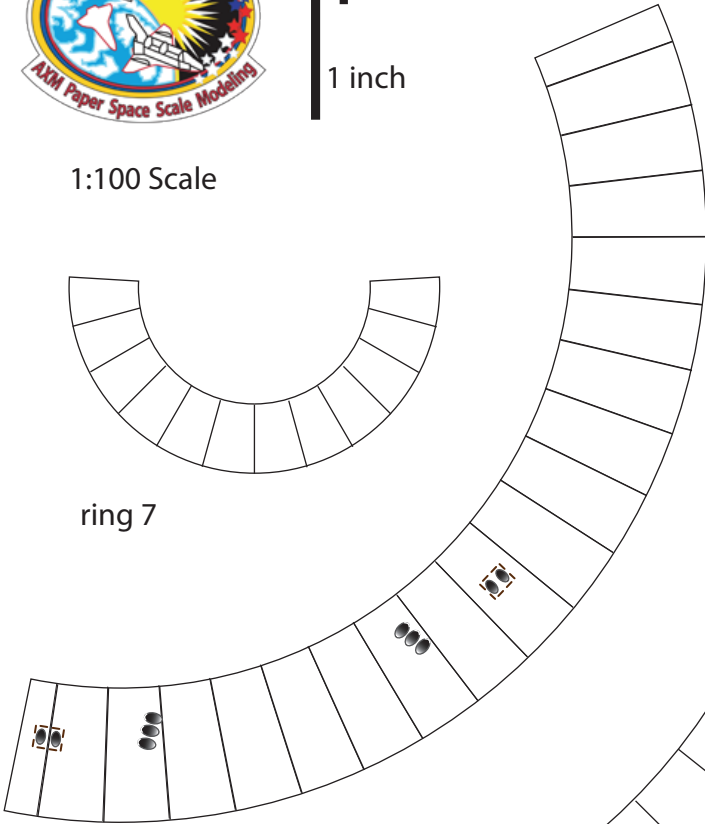

ring 5

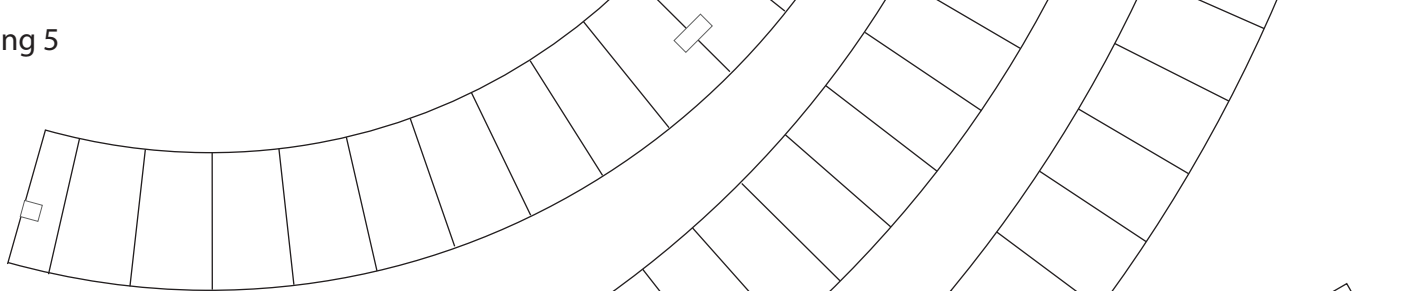

ring 4

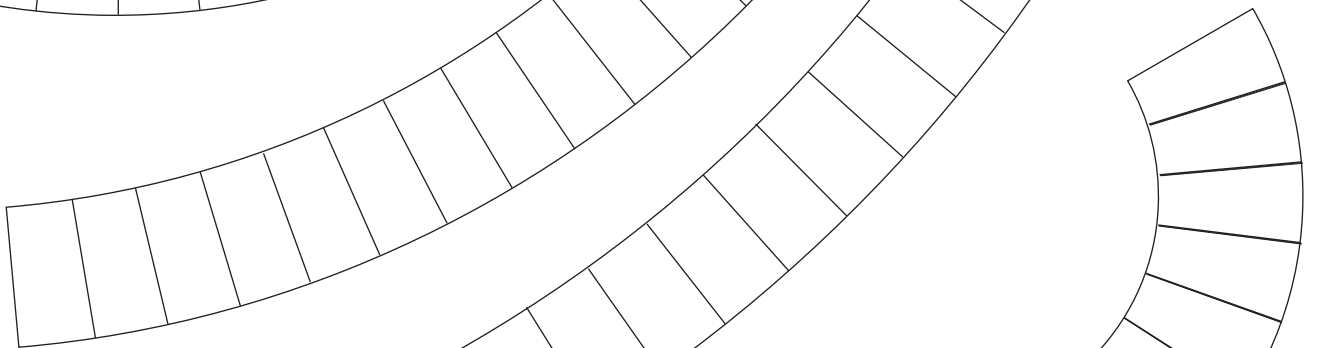

ring 3

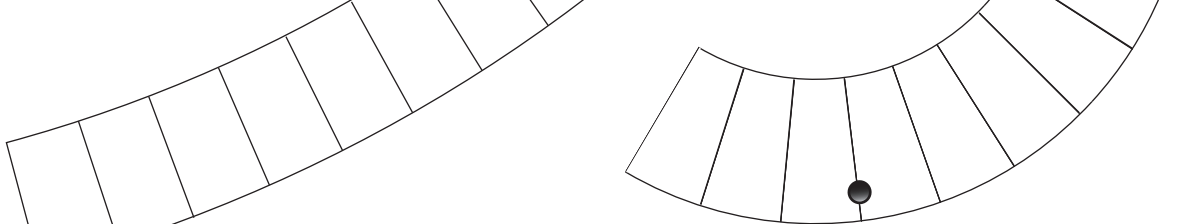

ring 2

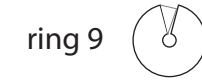

ring 9

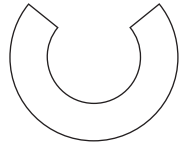

ring 8

ring 6

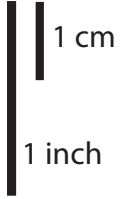

SpaceX Starship SN-8

Print on metallic paper
on its white side

1:100 Scale

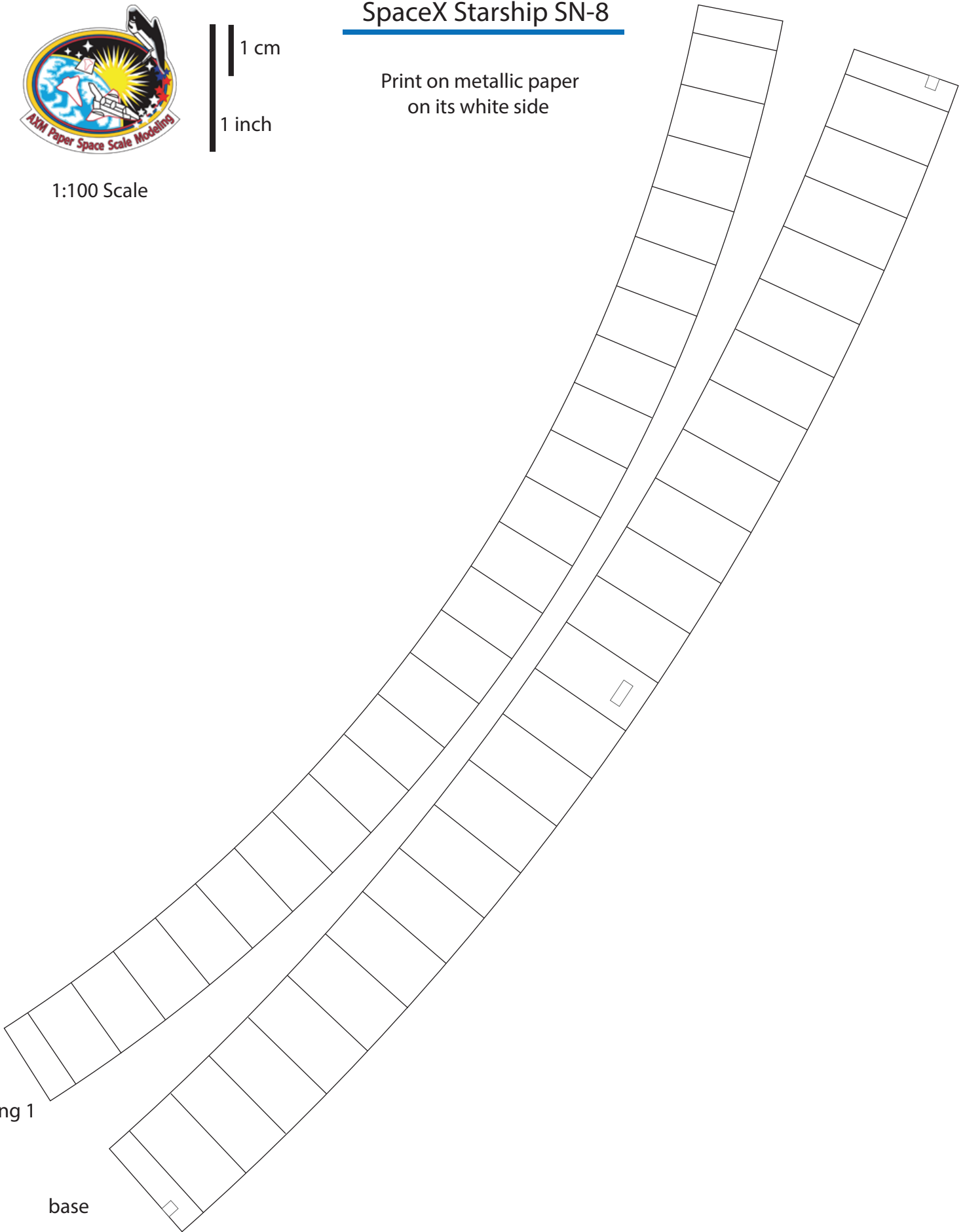

ring 1

base



1:100 Scale

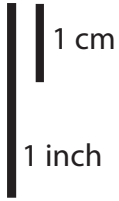

SpaceX Starship SN8

Print on Cardstock (110 lbs)

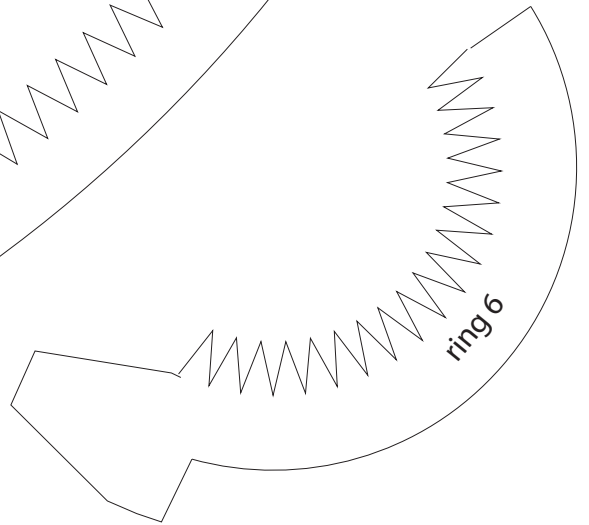
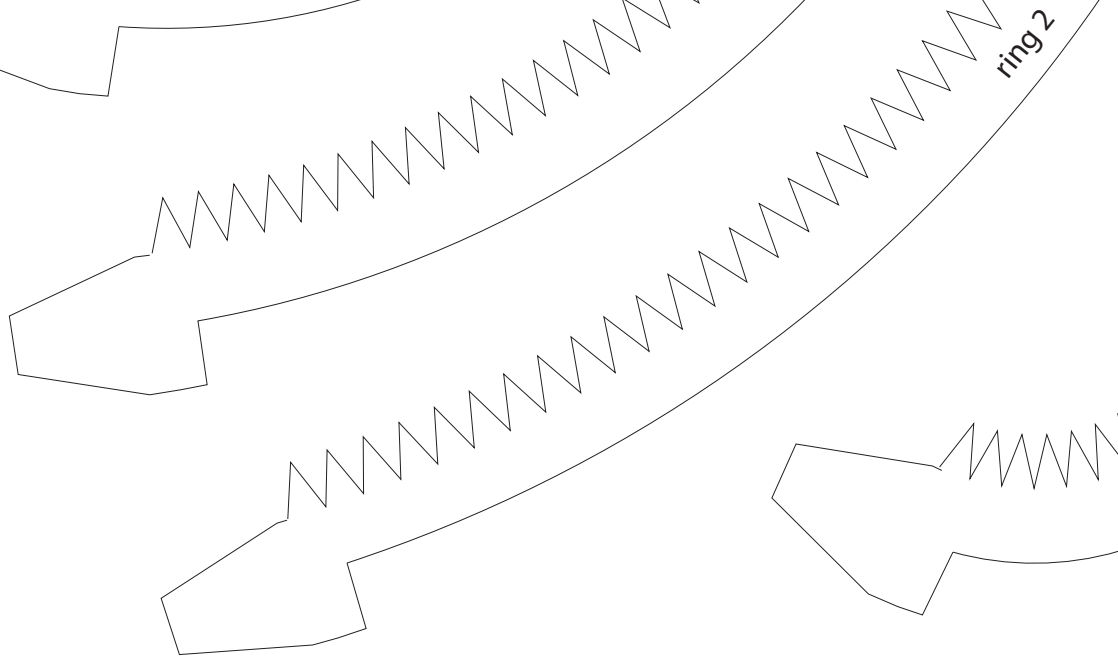
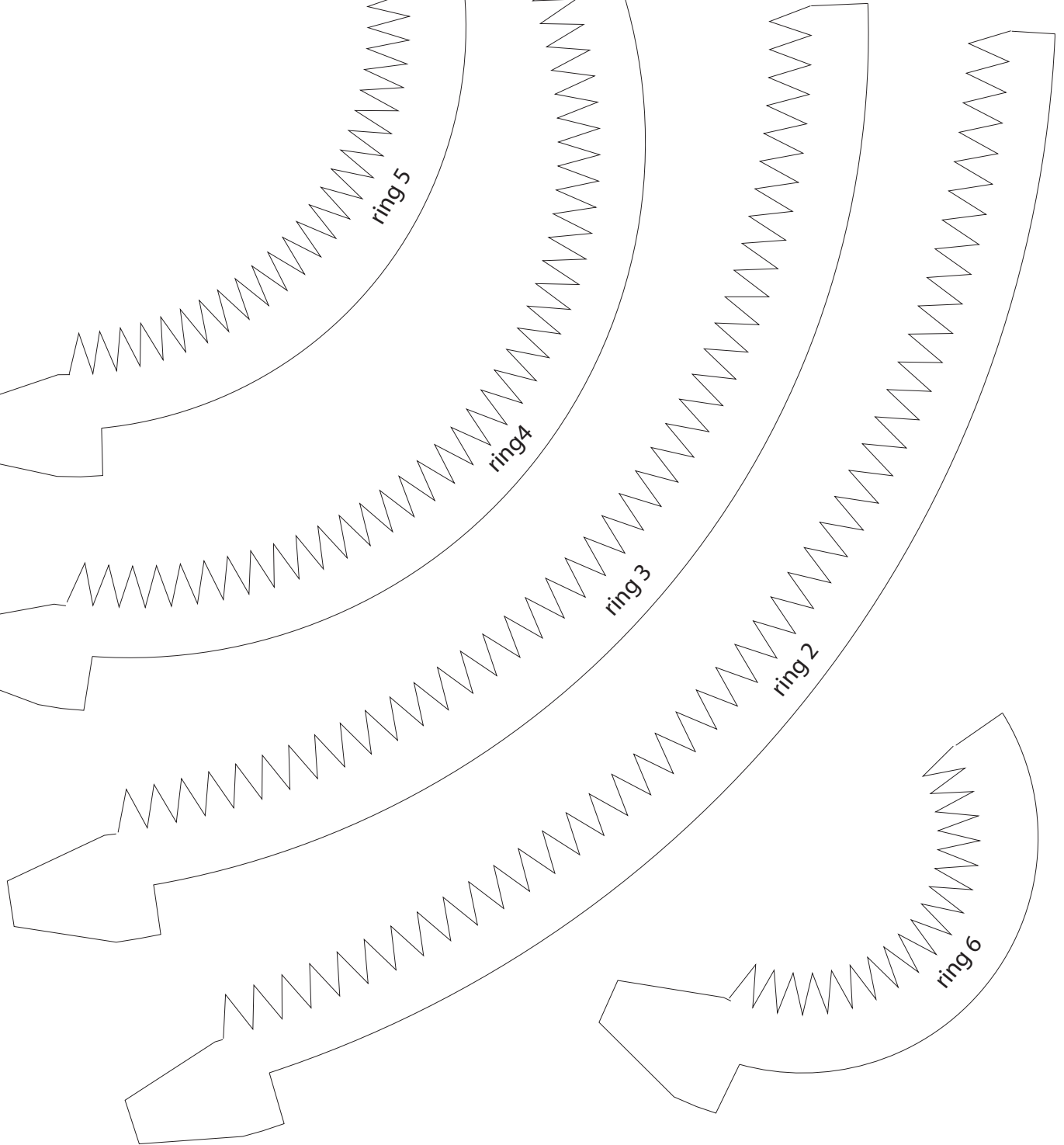
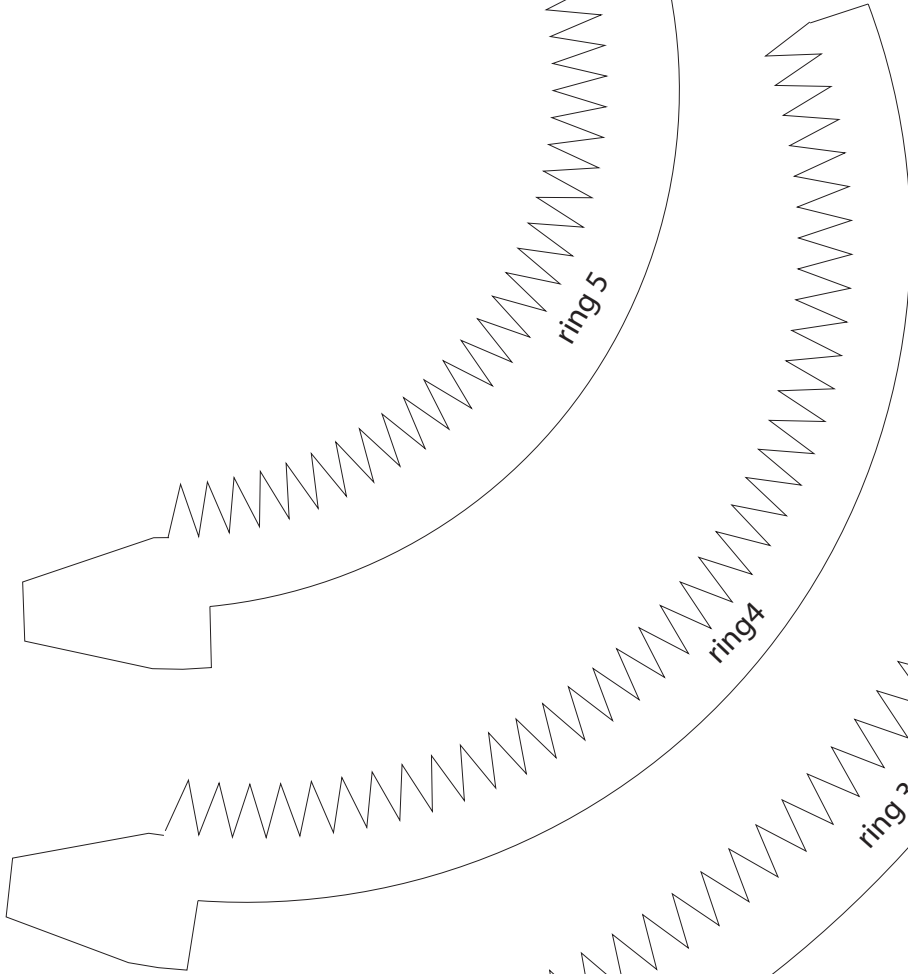
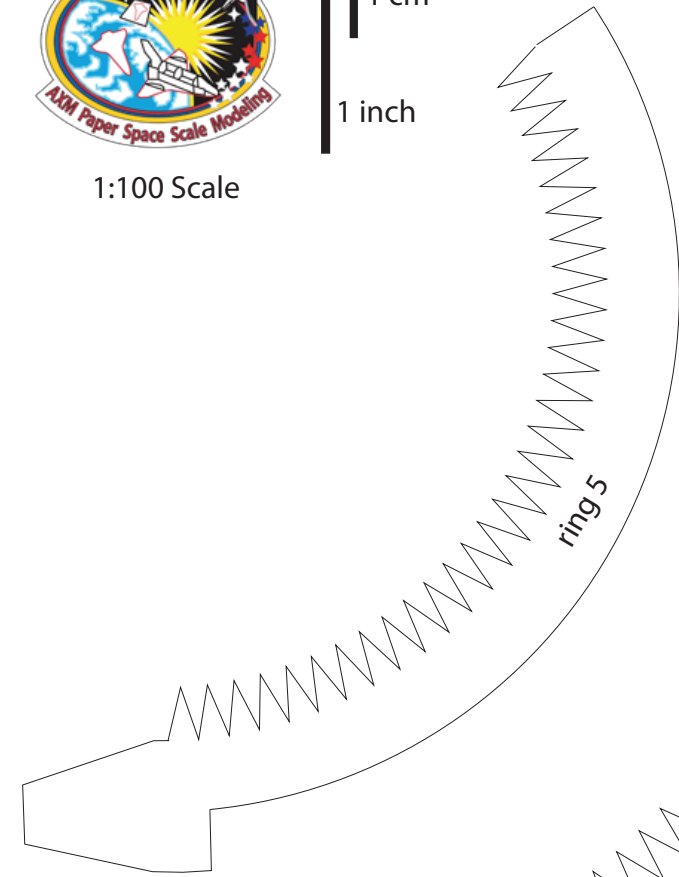
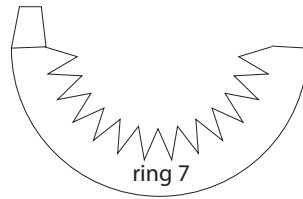



1:100 Scale

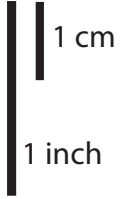

SpaceX Starship SN8

Print on Cardstock (110 lbs)

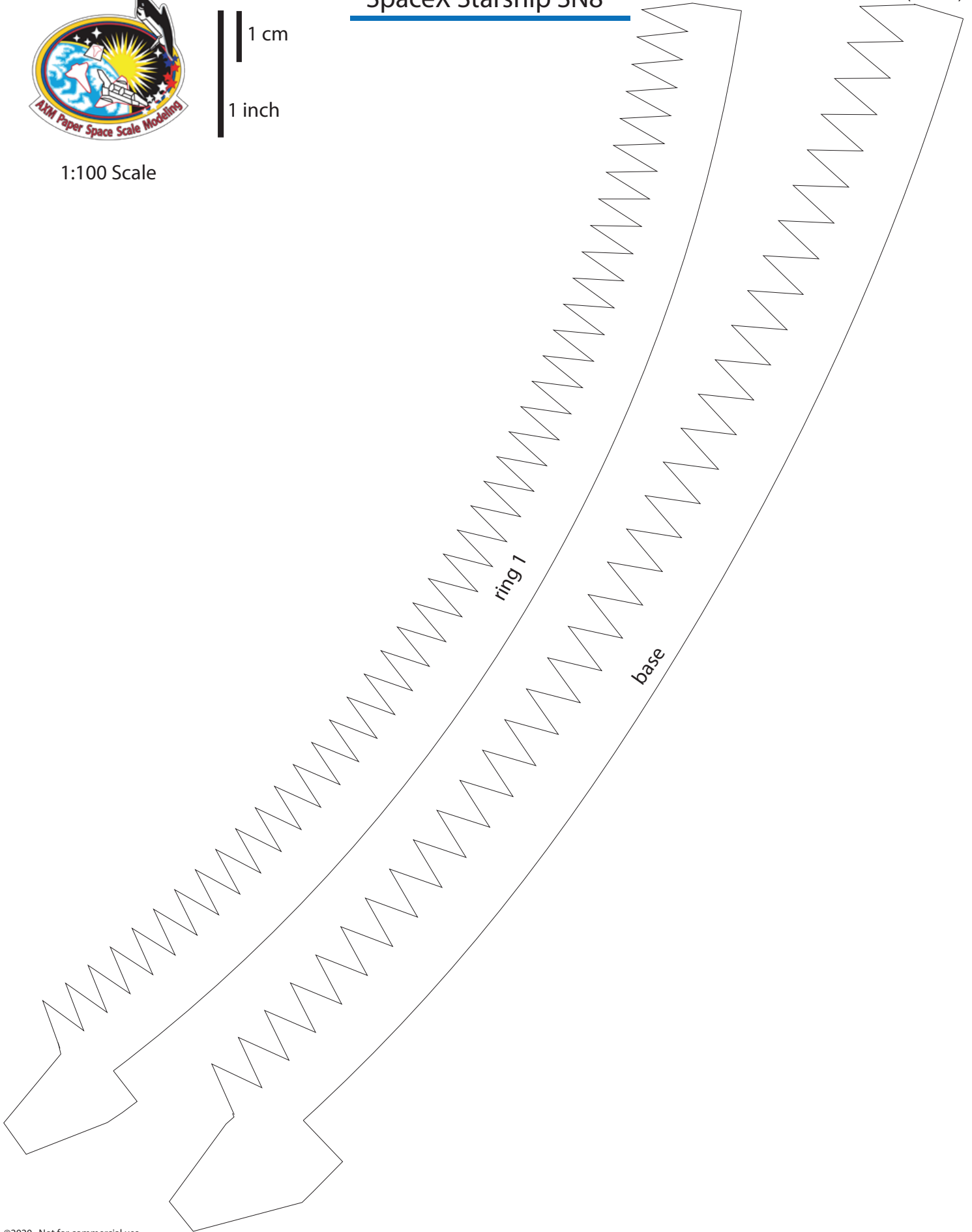



1:100 Scale



SpaceX Starship SN8

Print on Cardstock (110 lbs)

Header Tank

(Optional)

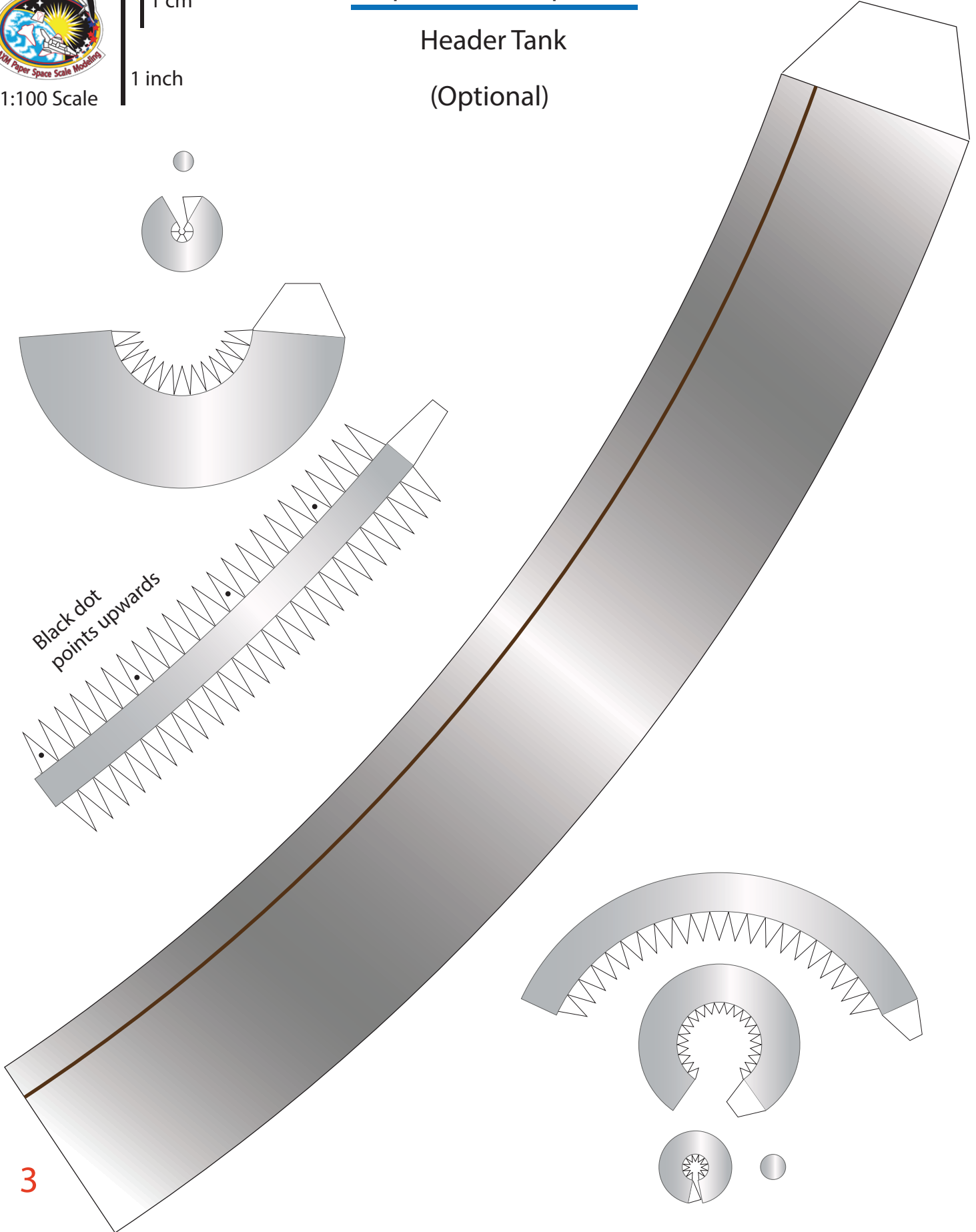

Black dot
points upwards

3



1:100 Scale



SpaceX Starship SN Nosecone interior

Print on Cardstock (110 lbs)

(Optional)

Nosecone interior parts in red.

1

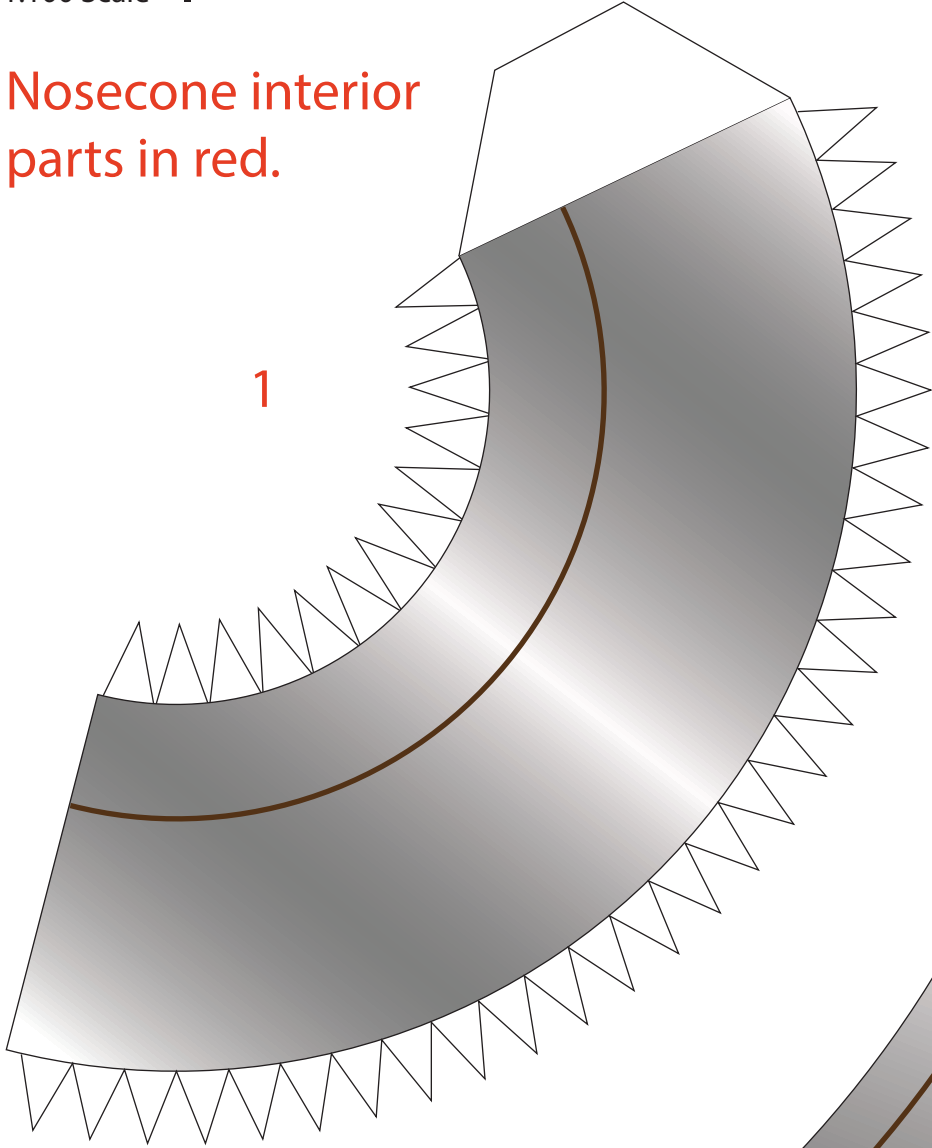

2

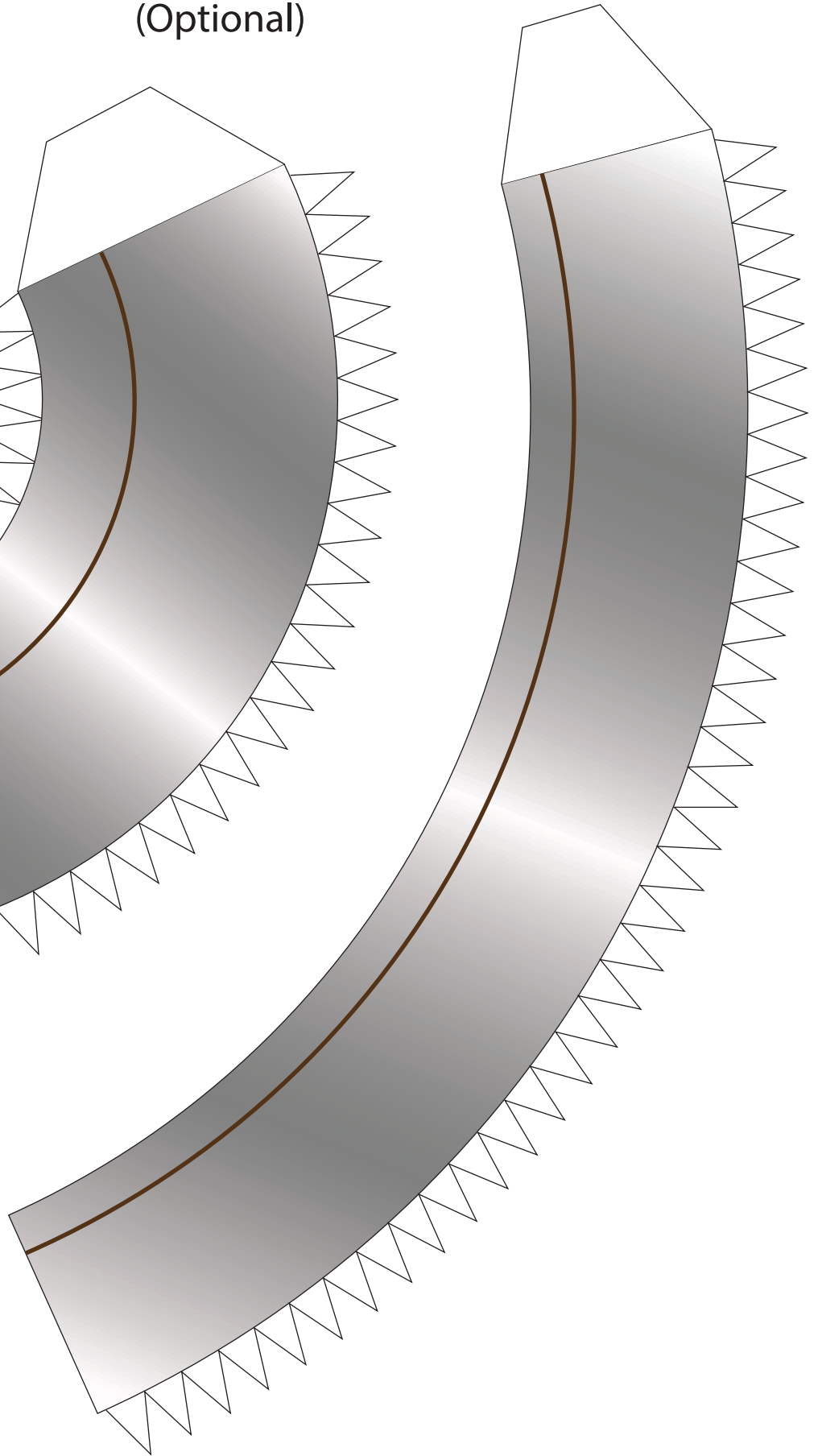



1:100 Scale



SpaceX Starship SN

Print on Cardstock (110 lbs)

(Optional)

Header Tank

Nosecone interior parts in red.

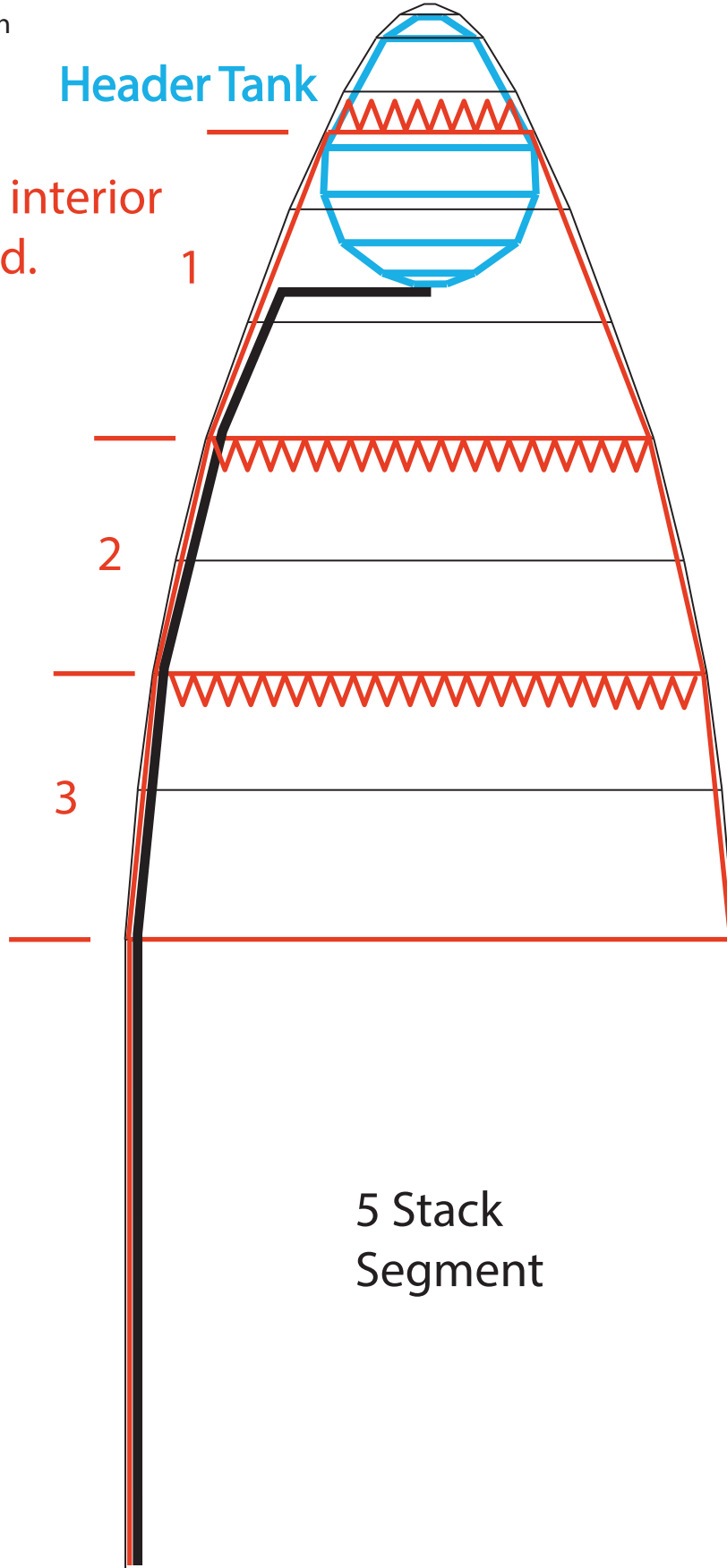

Header Tank pipe

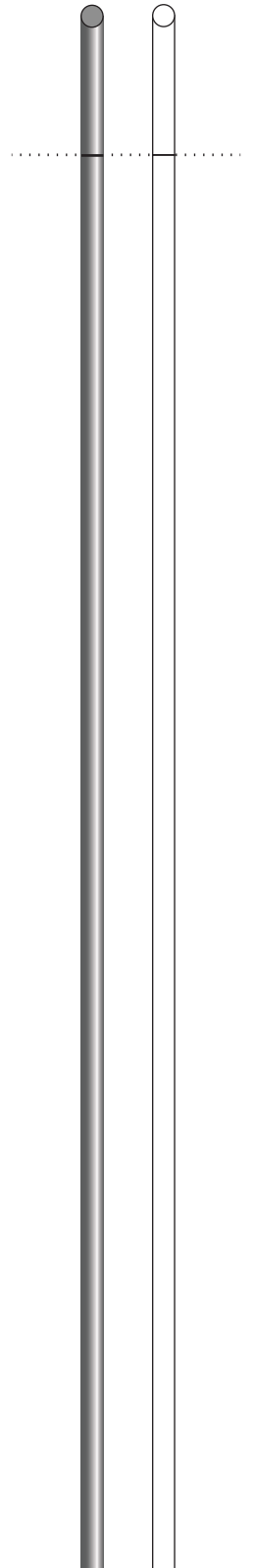



1:100 Scale

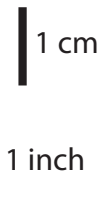

SpaceX Starship SN8

Nosecone-body 5 ring stack

Print on metallic paper
on its white side

Umbilical
side

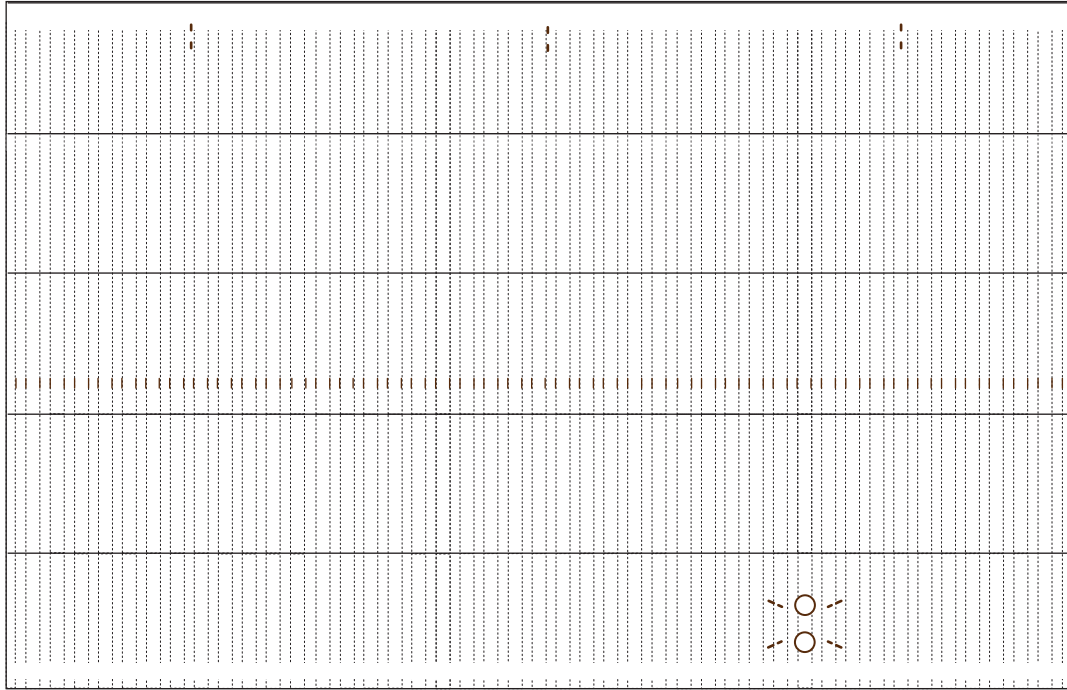

Front

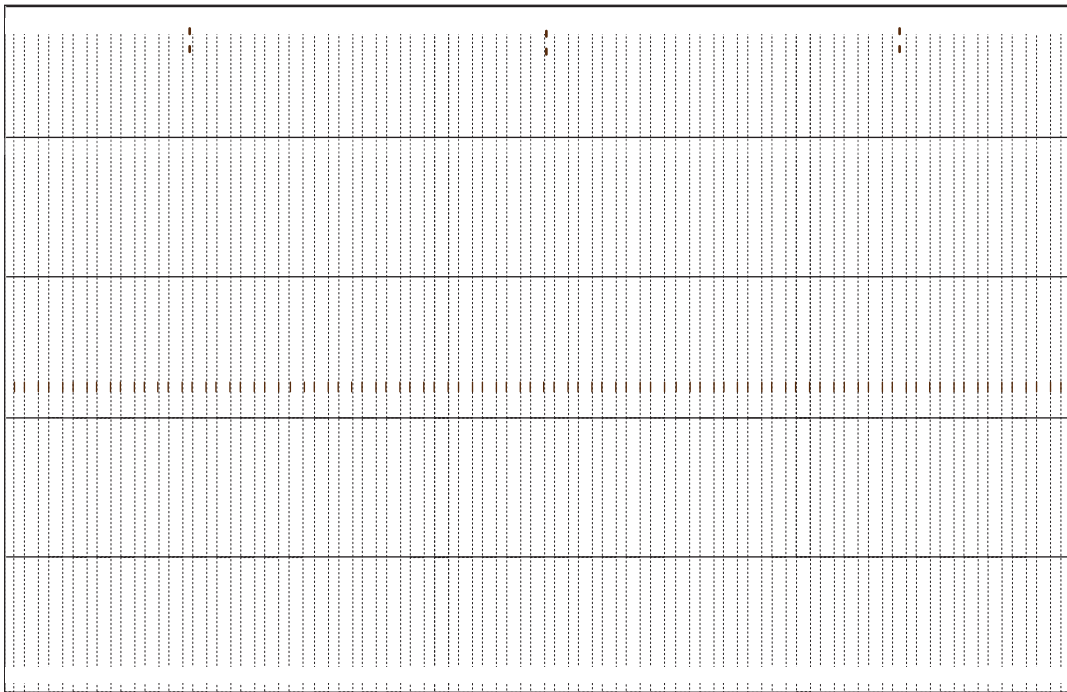



1:100 Scale



SpaceX Starship SN8

Print on Cardstock (110 lbs)

Nosecone-body 5 ring stack interior detail

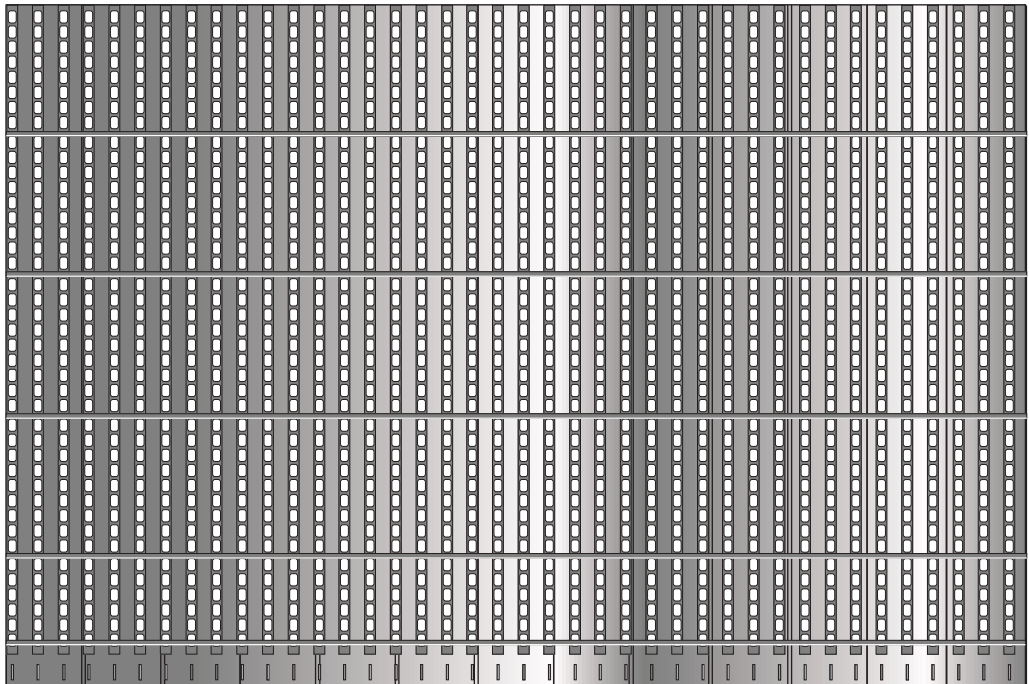
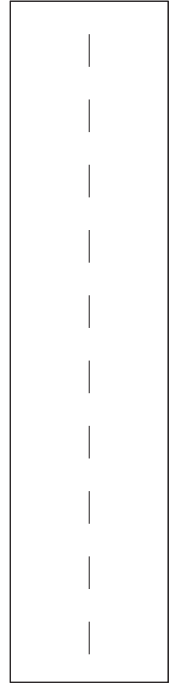
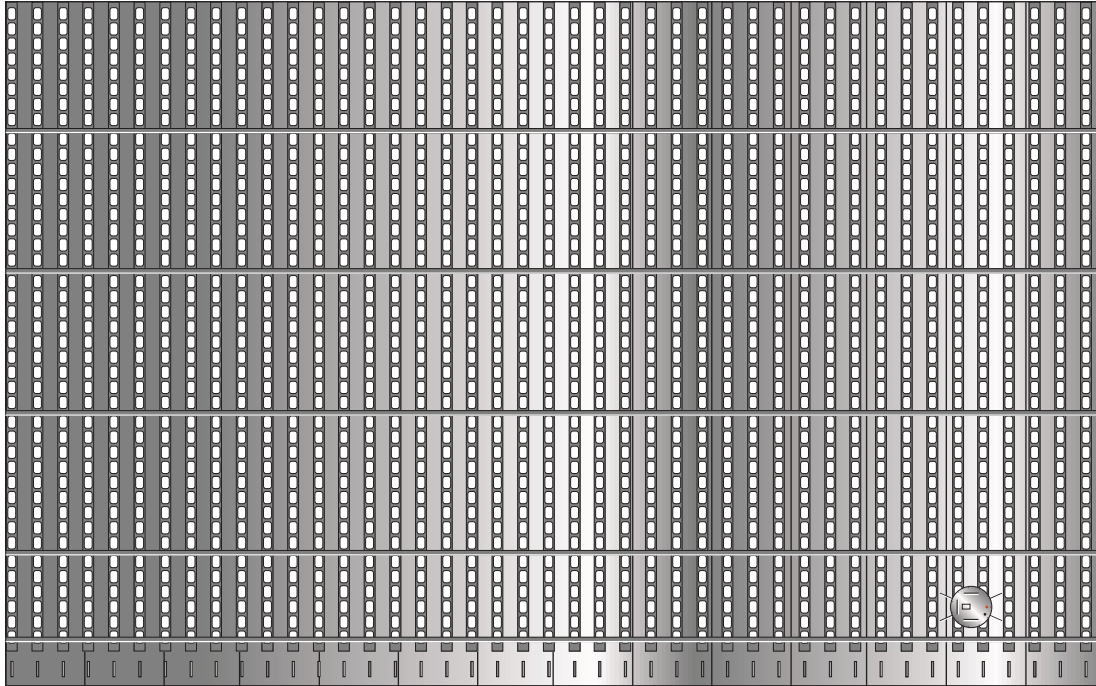



1 cm

1 inch

1:100 Scale

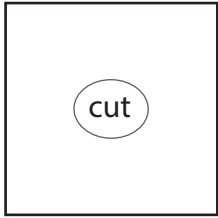
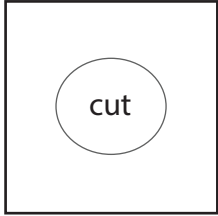

templates to score
inner circles

SpaceX Starship SN8

Print on metallic paper
on its white side

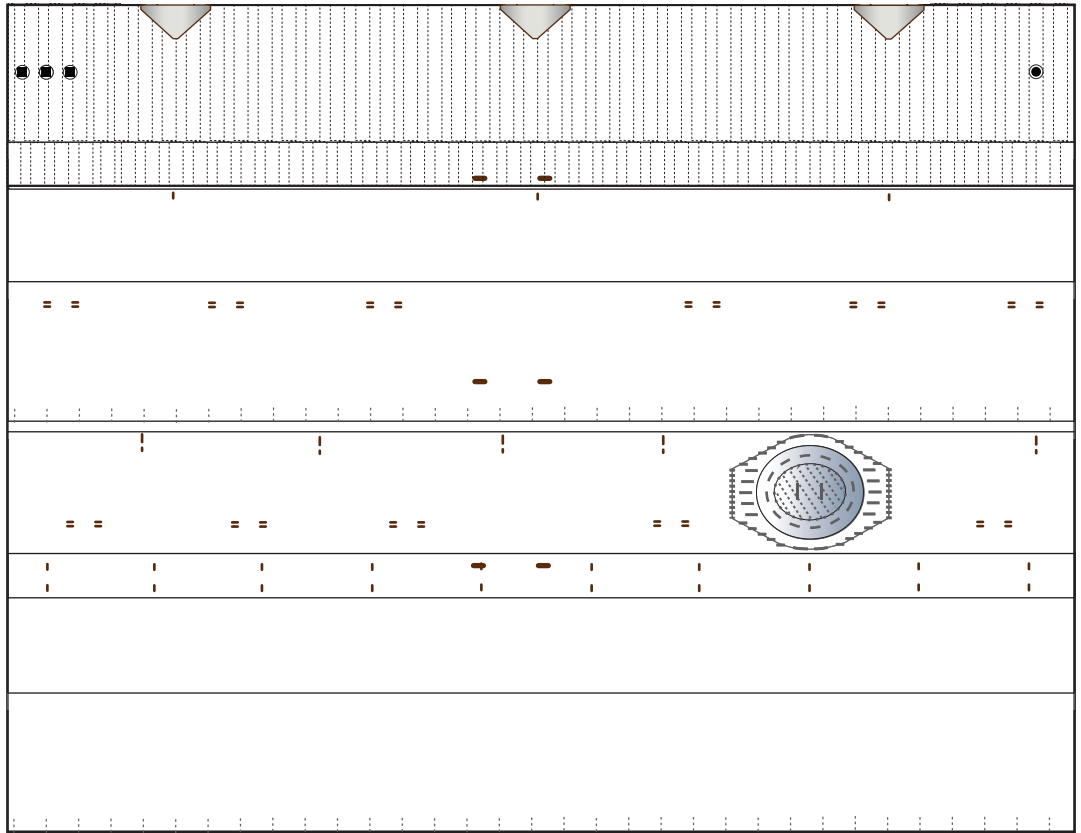

Belly top

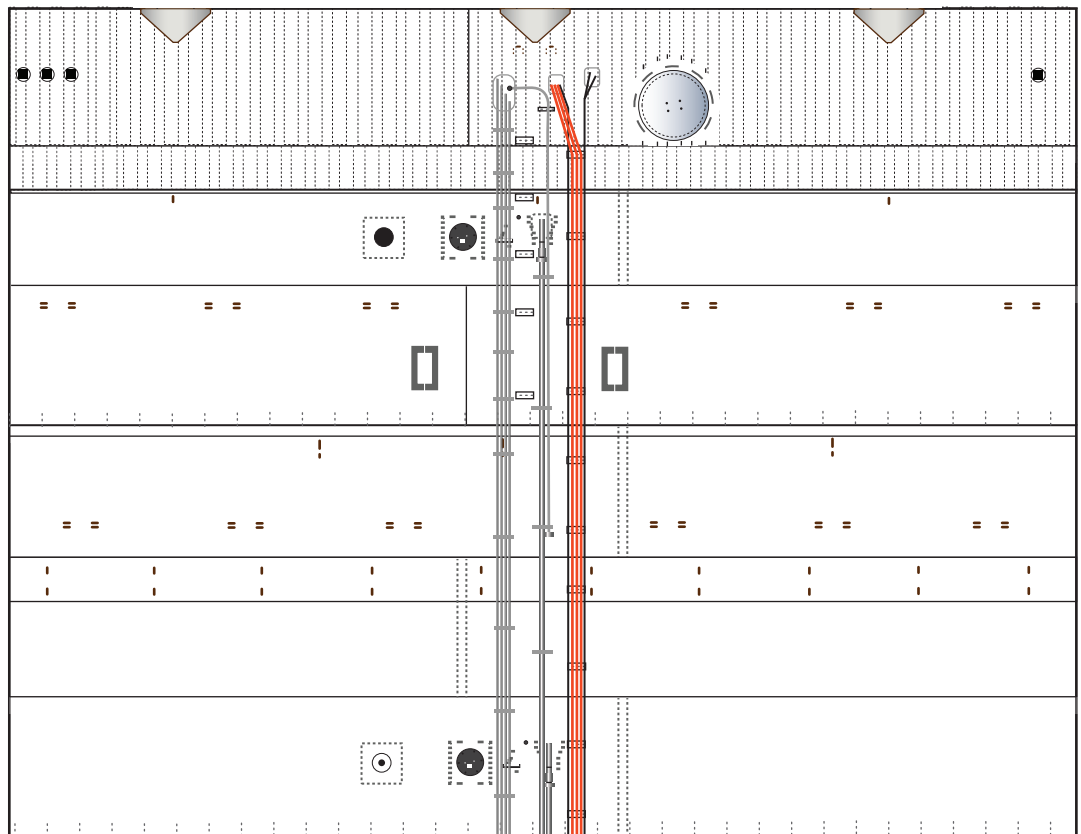

Back top



1:100 Scale



SpaceX Starship SN8

Print on metallic paper
on its white side

Belly side bottom

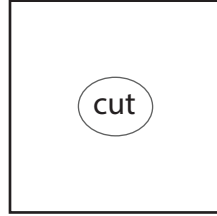
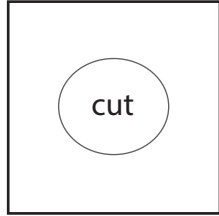

templates to score
inner circles

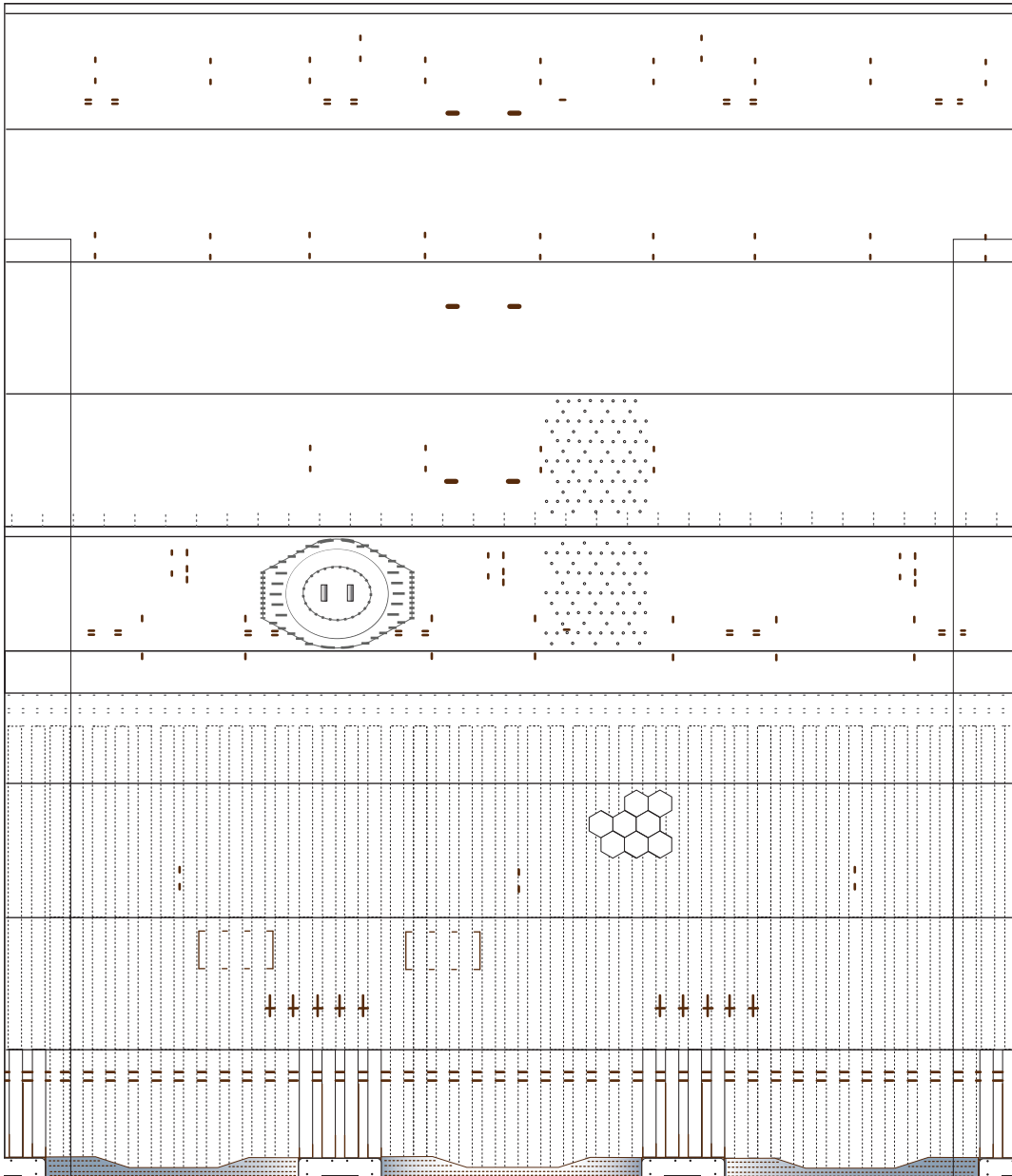



1:100 Scale



SpaceX Starship SN8

Print on metallic paper
on its white side

Back bottom

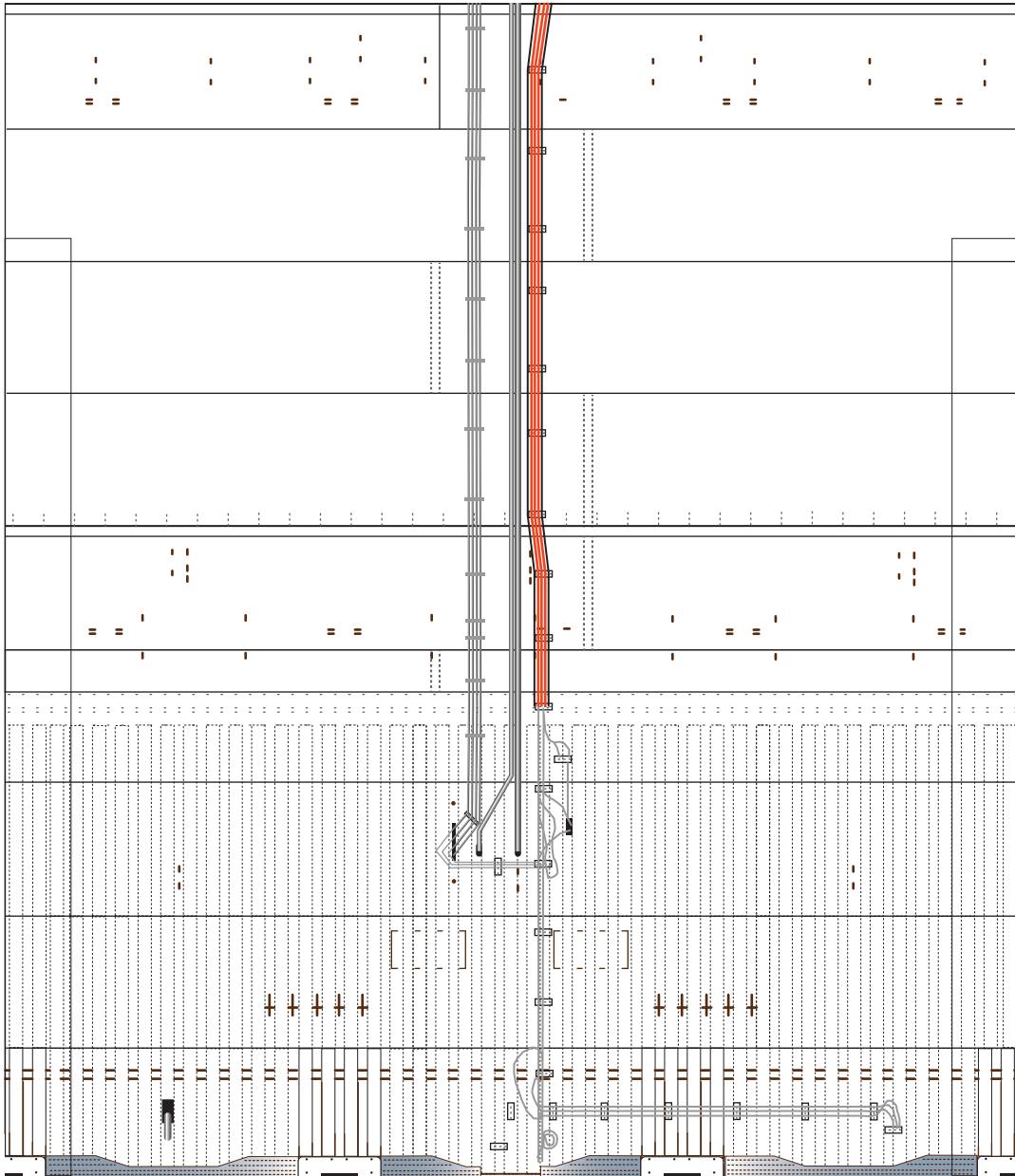



1:100 Scale



SpaceX Starship SN8

Print on Decal Paper

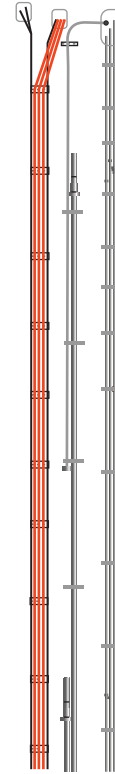
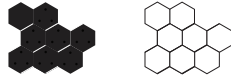

Umbilicals

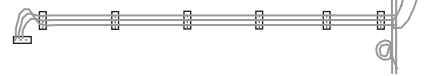
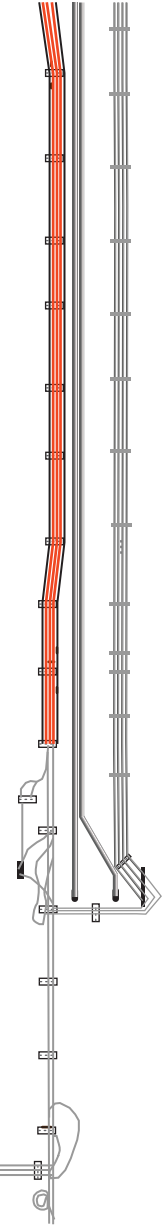

Canards

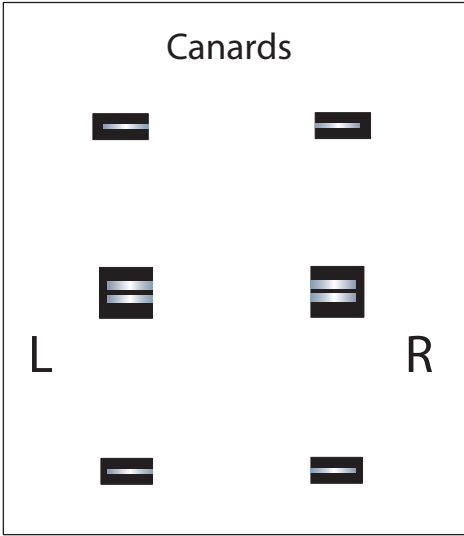

Wing Supports

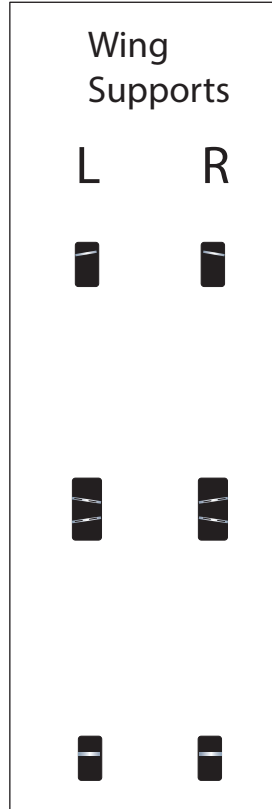

Wings

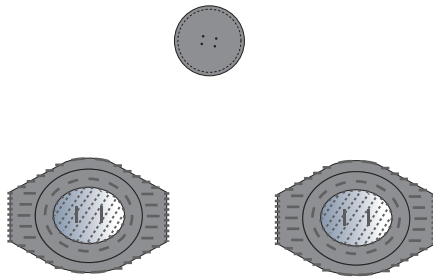
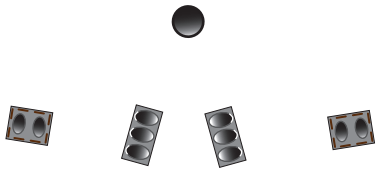
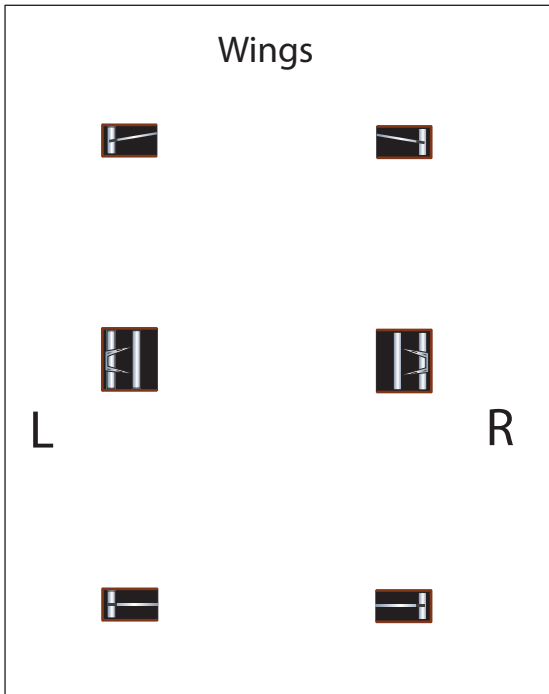



1:100 Scale



SpaceX Starship SN8

Print on Cardstock (110 lbs)

Connectors for 5 ring
stack and body

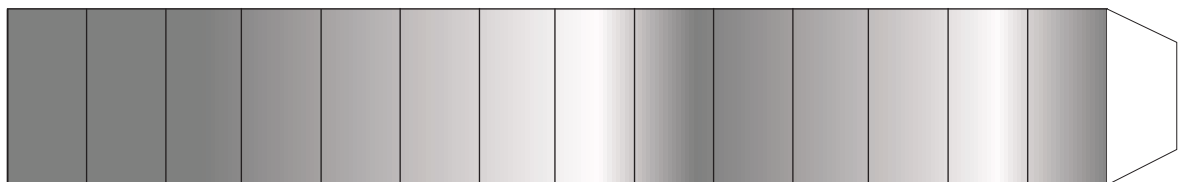
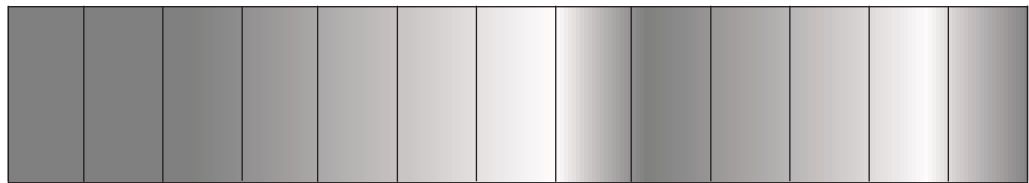
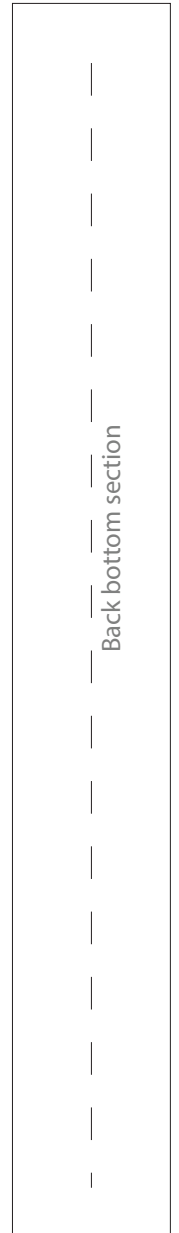
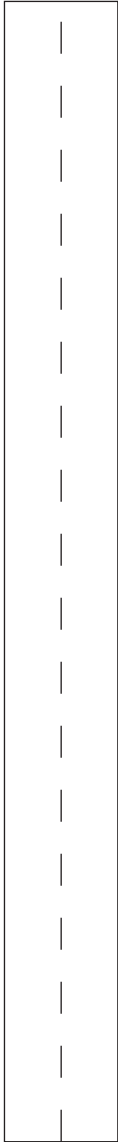
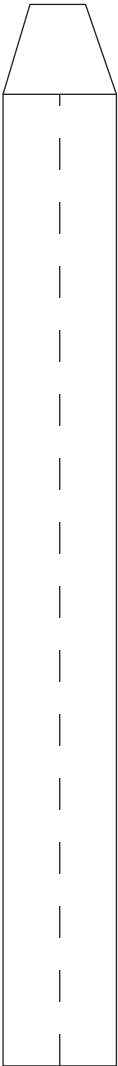



1:100 Scale

SpaceX Starship SN8

Print on metallic paper
on its white side

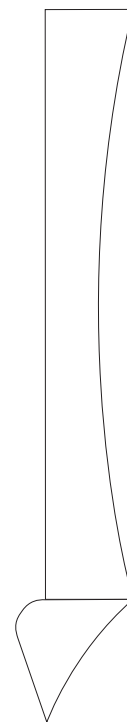
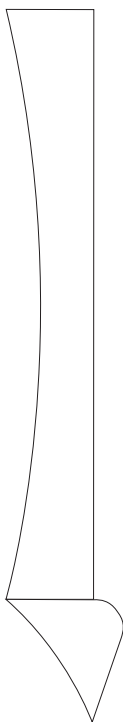
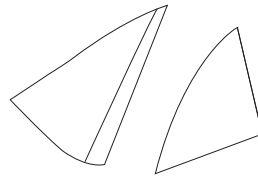
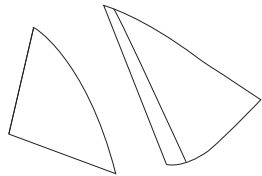
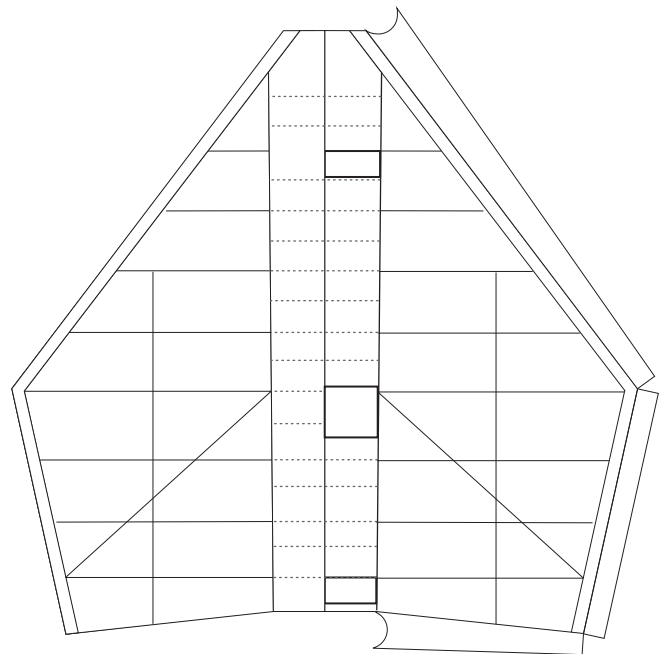
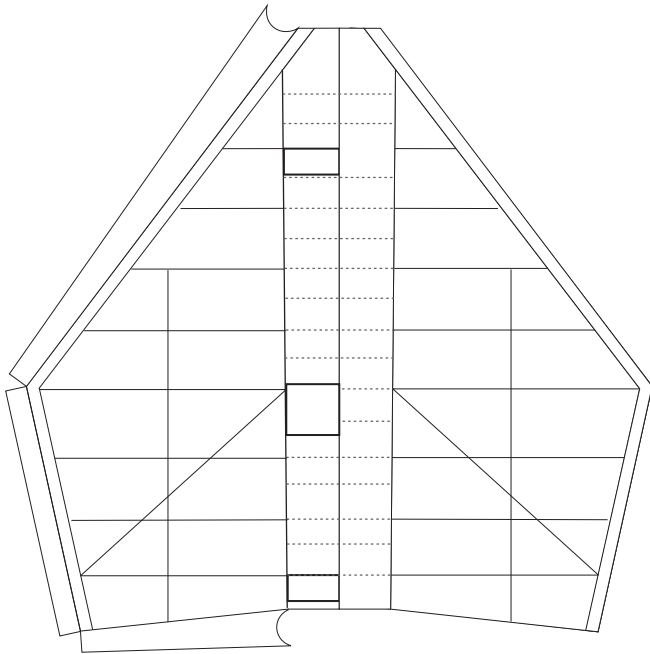
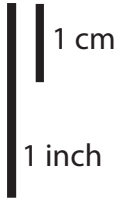



1:100 Scale

SpaceX Starship SN8

Print on Cardstock (110 lbs)

1 cm

1 inch

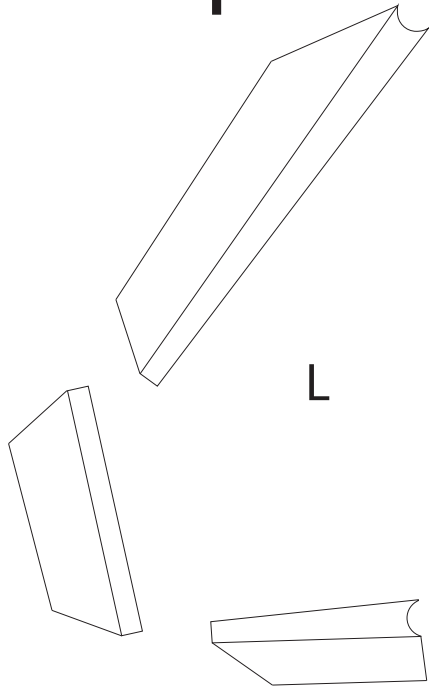

L

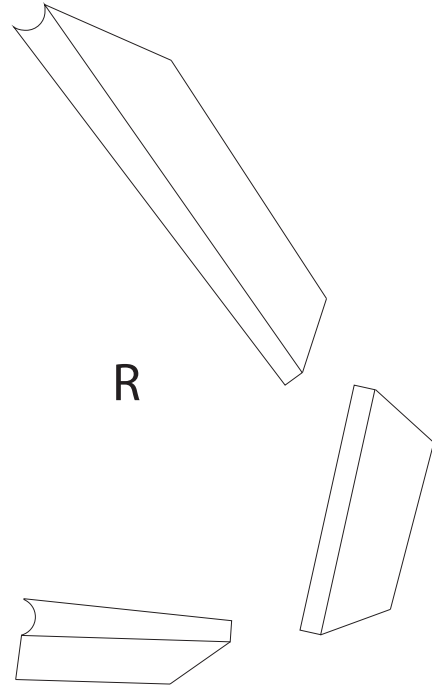

R

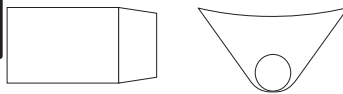
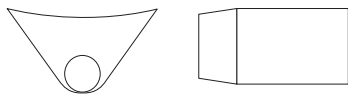
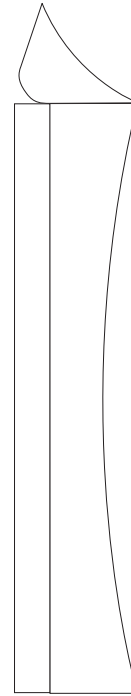
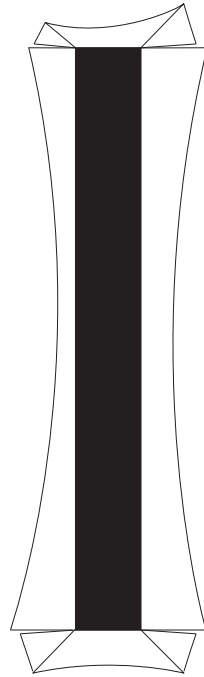
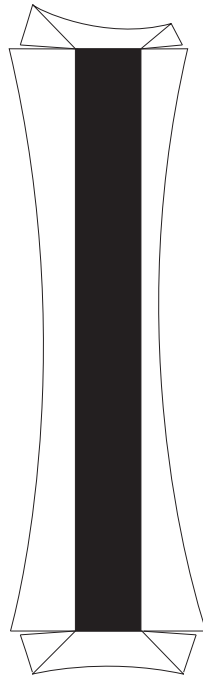
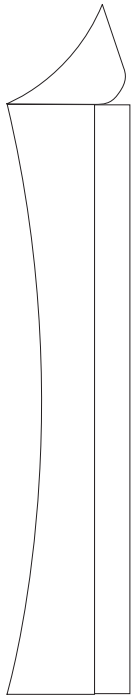
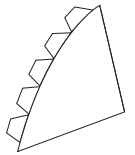
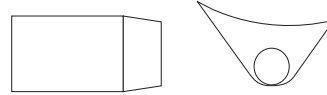
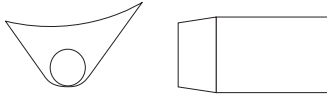
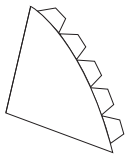



1:100 Scale



SpaceX Starship SN8

Print on metallic paper
on its white side

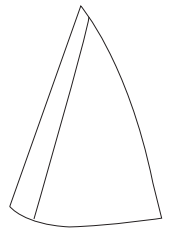
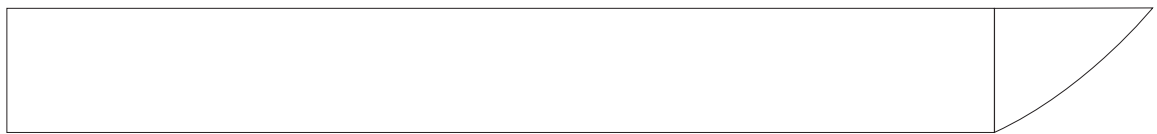
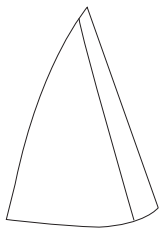
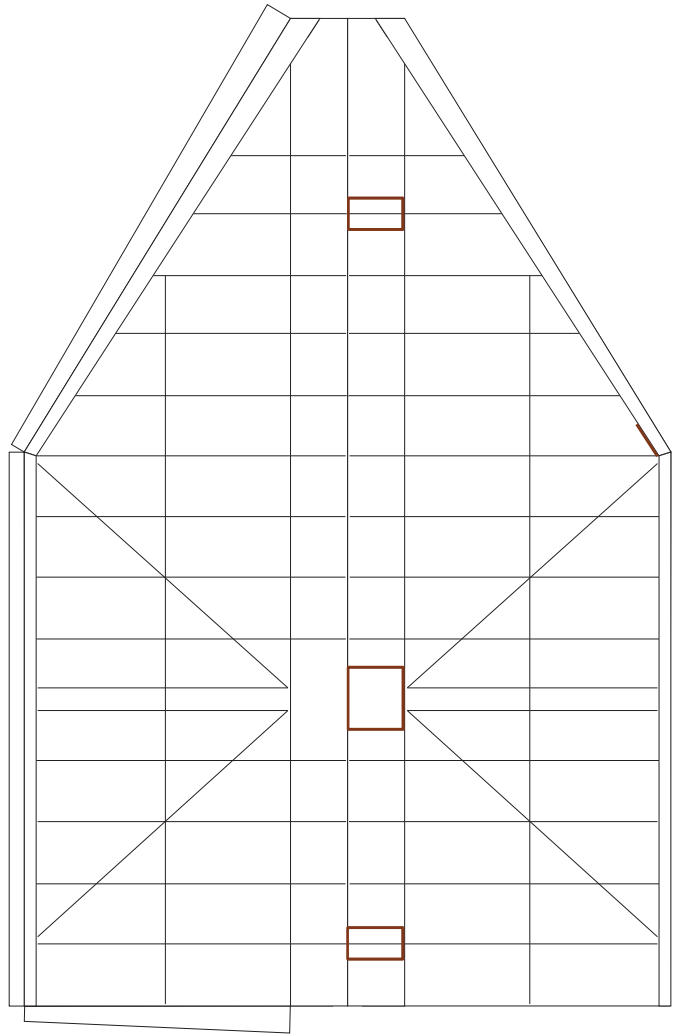
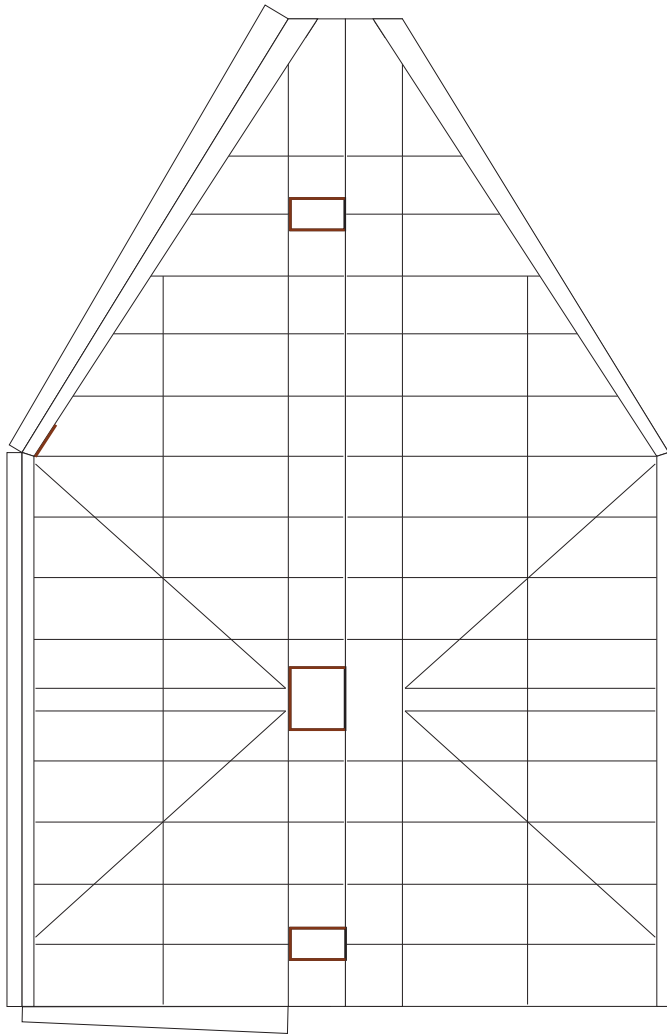



1:100 Scale

SpaceX Starship SN8

Print on Cardstock (110 lbs)

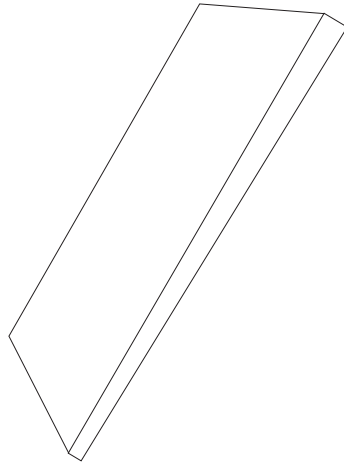
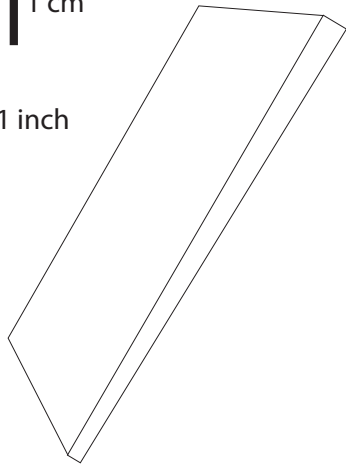

L

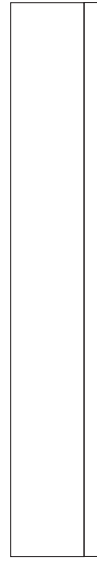

R

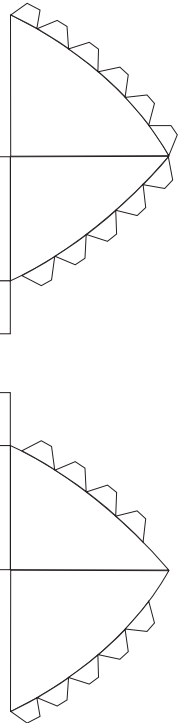
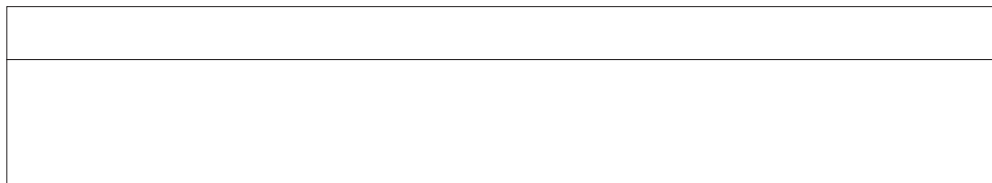
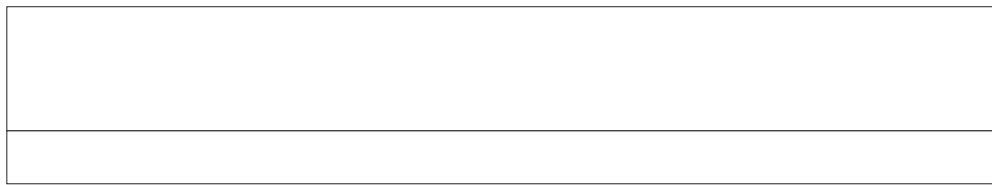
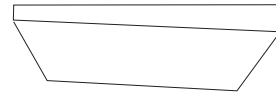



1:100 Scale

SpaceX Starship SN8

Print on Cardstock (110 lbs)

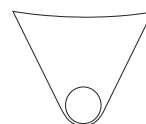
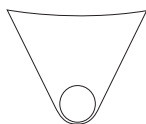
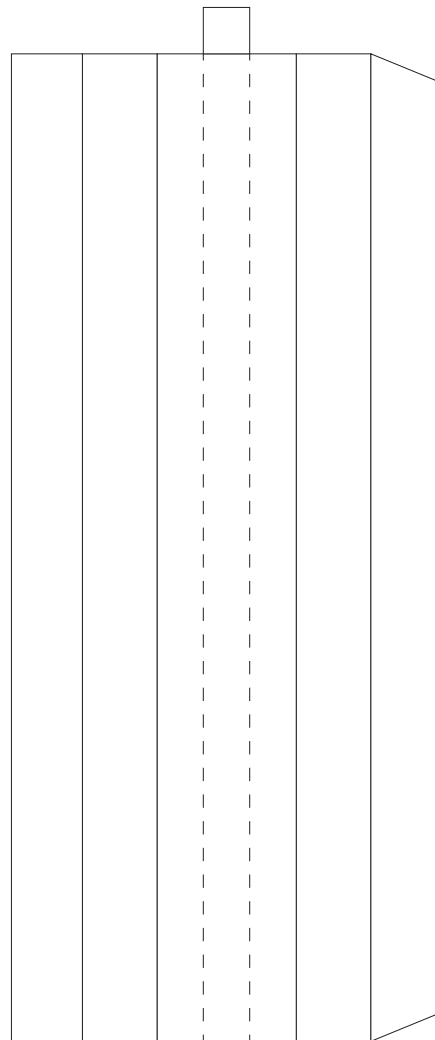
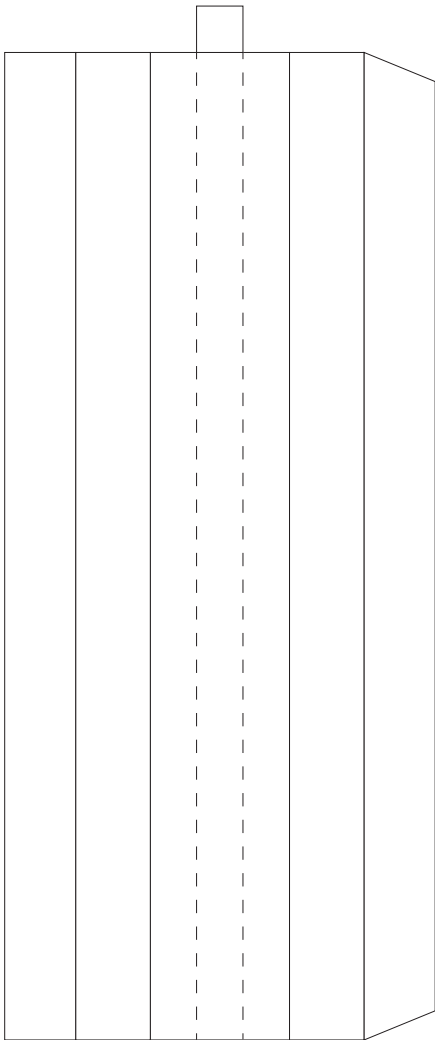
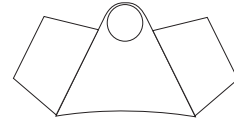
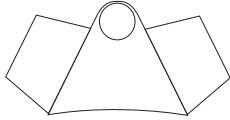
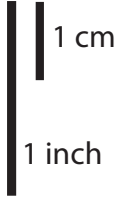



1:100 Scale



SpaceX Starship SN-8

Former for upper dome

Print on Cardstock (110 lbs)

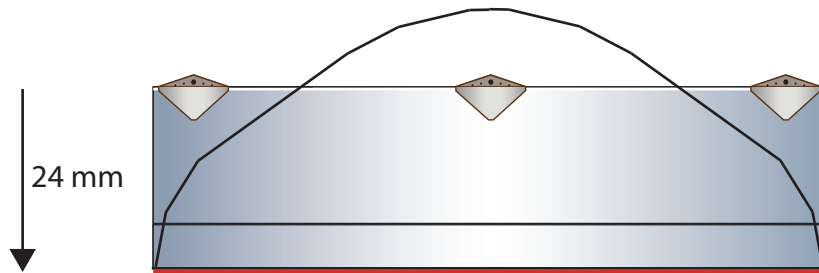
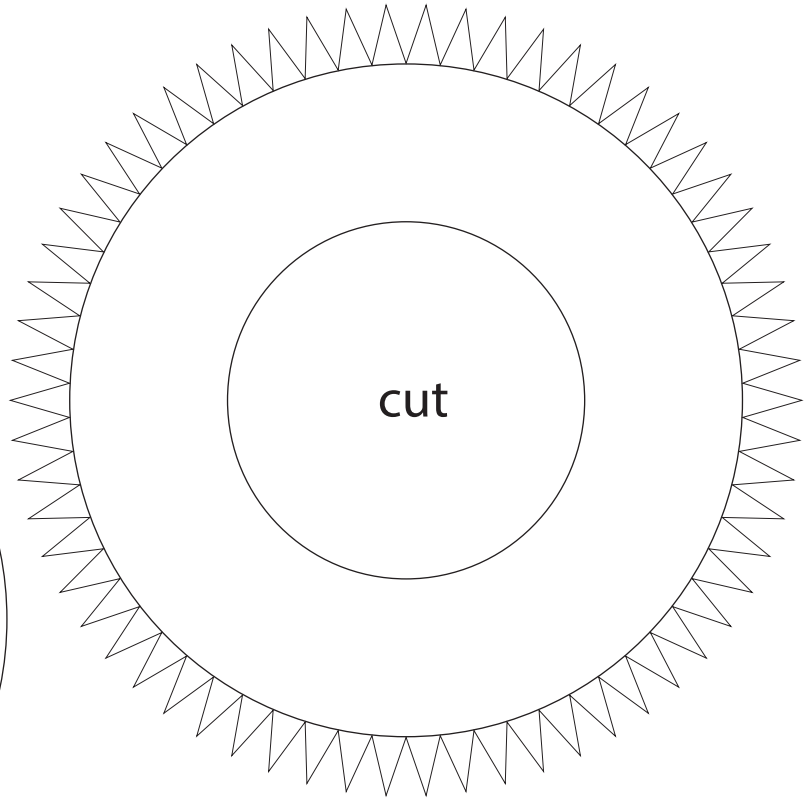
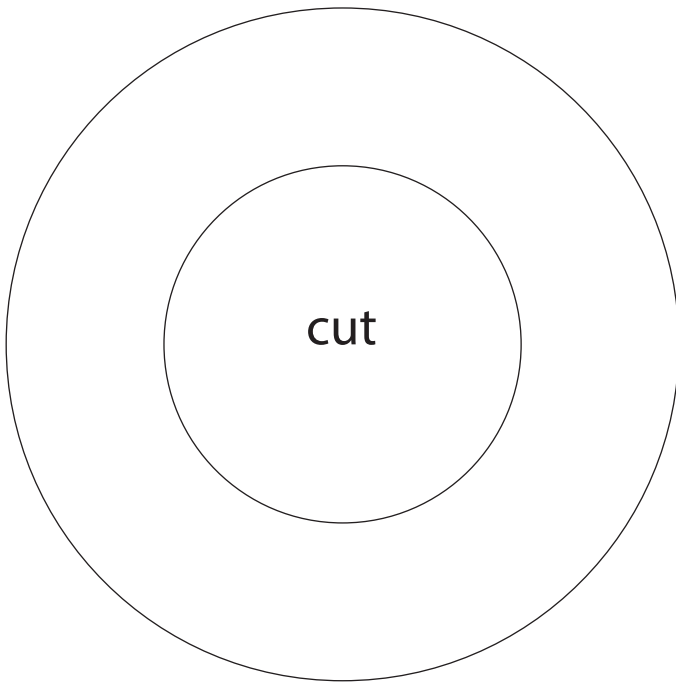

IMPORTANT

Top former is glued 24 mm from top edge of upper body for Starship SN-8 model



1 cm

1 inch

1:100 Scale

Starship SN8 Upper Dome

Print on Cardstock (110 lbs)

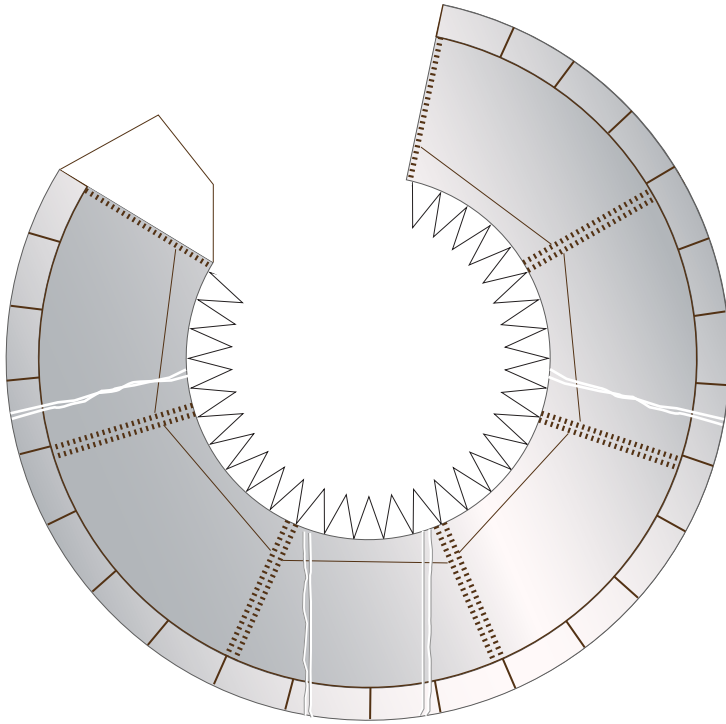
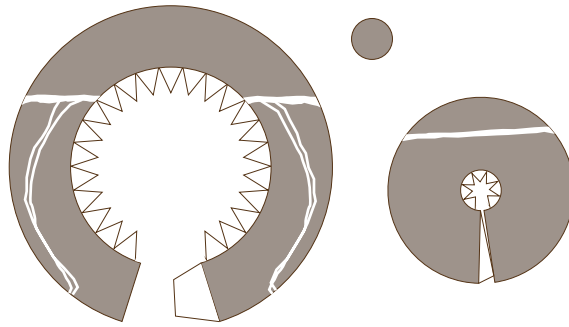

↔
Tesla
Battery

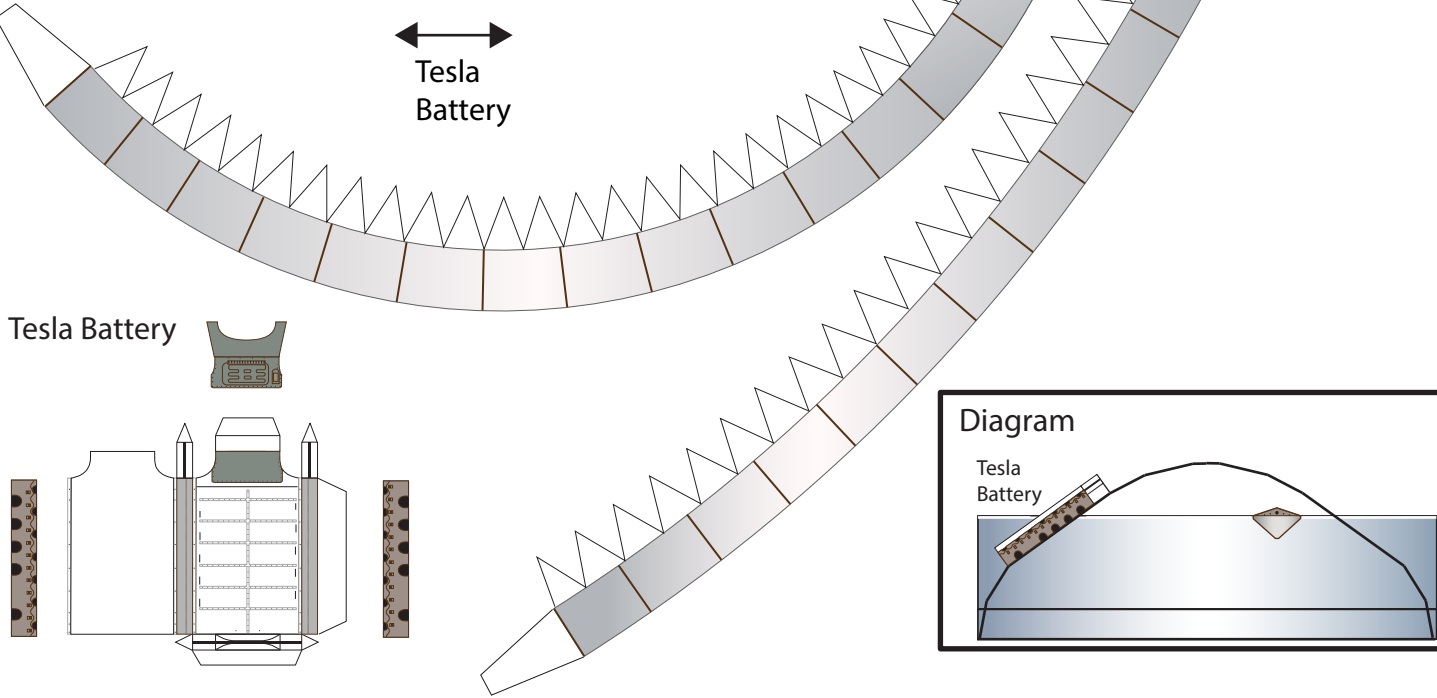

Tesla Battery

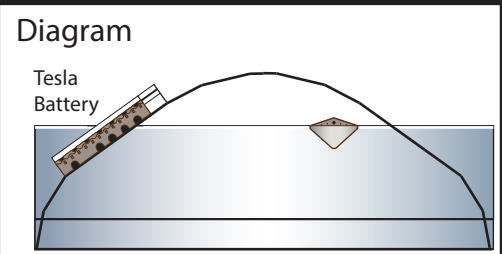
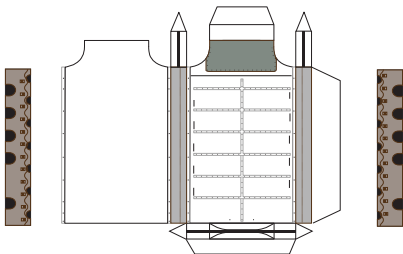



1:100 Scale



SpaceX Starship SN8

Print on Cardstock (110 lbs)

Formers for lower body

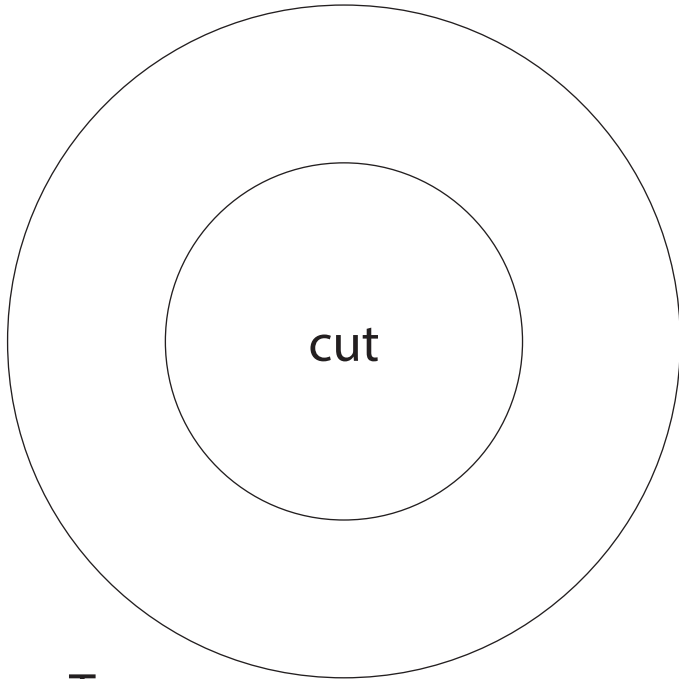

Top

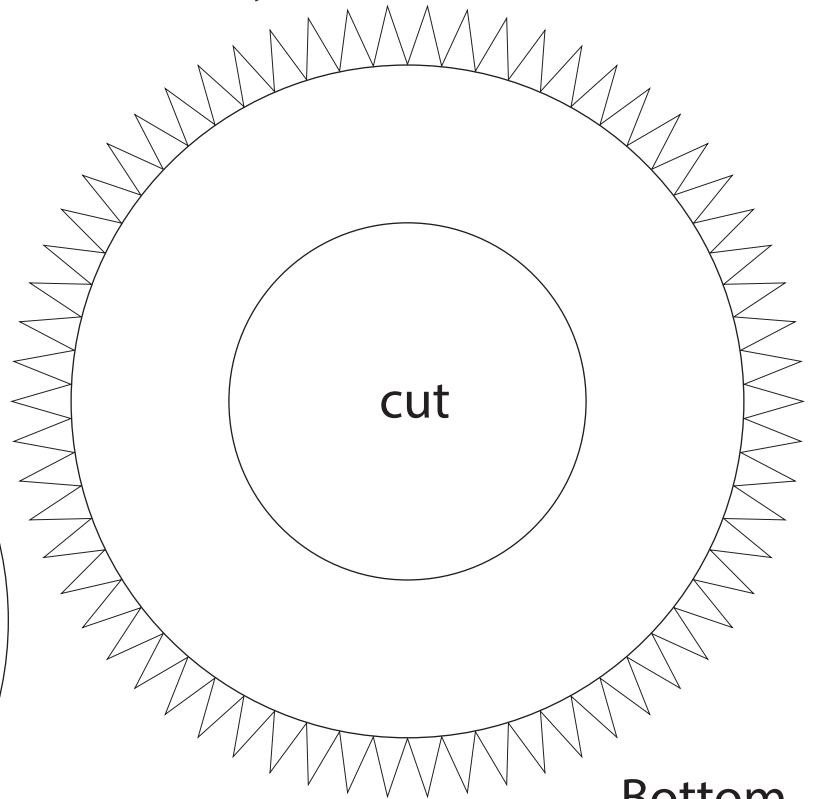

Bottom

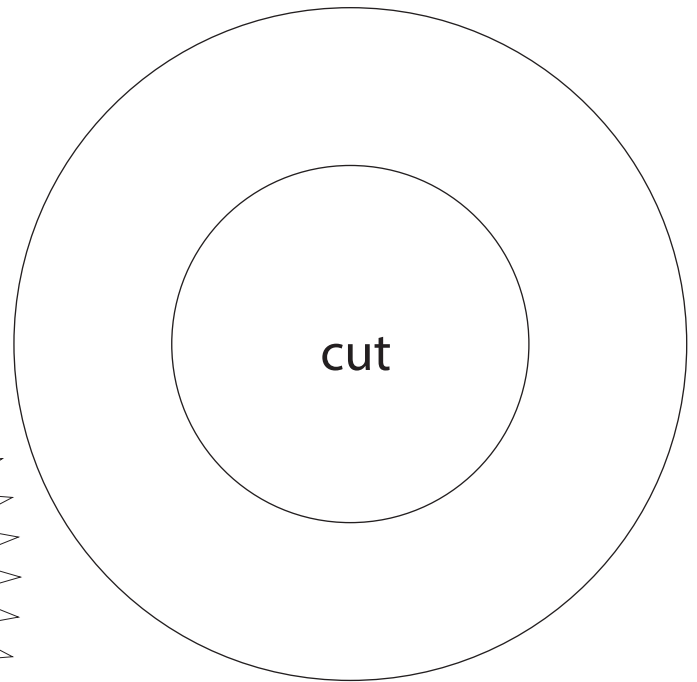
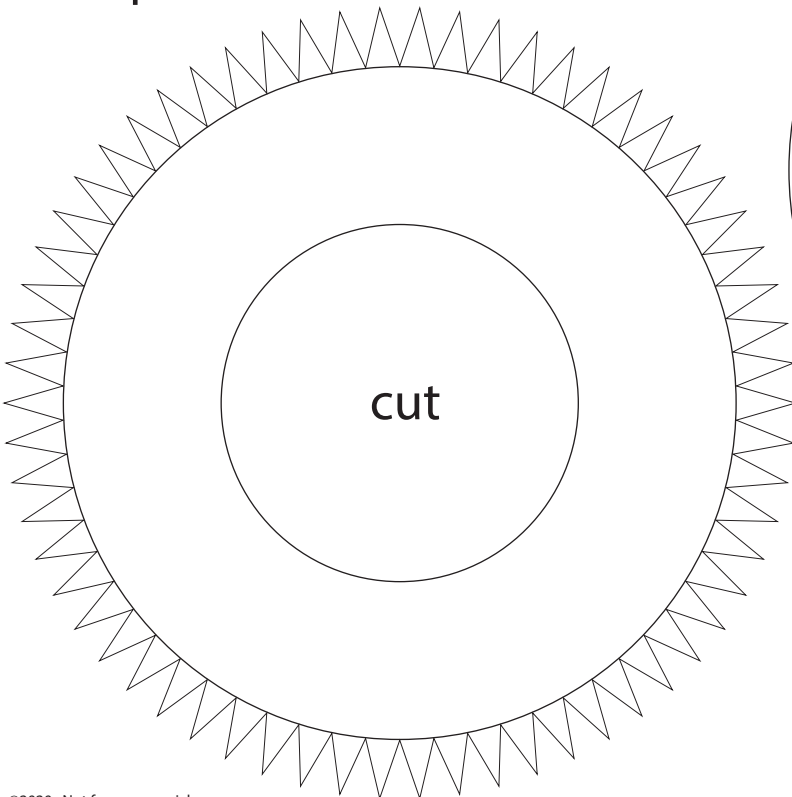

IMPORTANT

Top former is glued 20 mm from bottom edge of upper body.
Bottom former is glued 66 mm from bottom edge of lower body.



1 cm

1 inch

1:100 Scale

SpaceX Starship SN8

Print on Cardstock (110 lbs)

Revised

Connectors for
nosecone

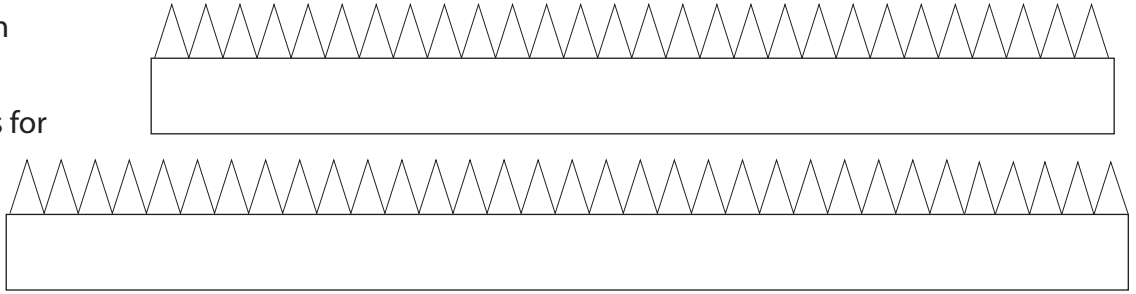

Connectors for upper
and lower body



Engine section
interior wall

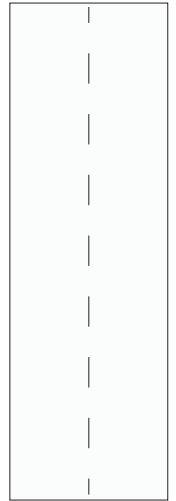
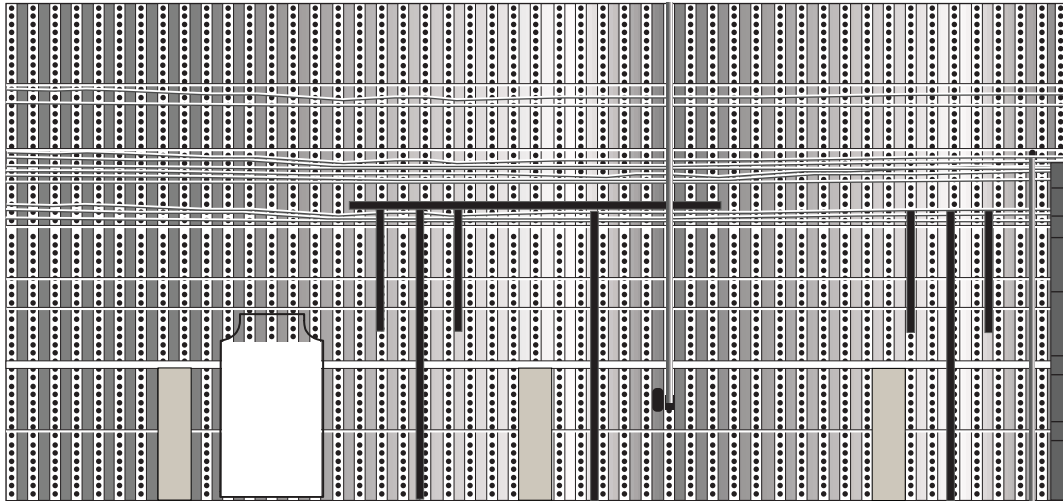
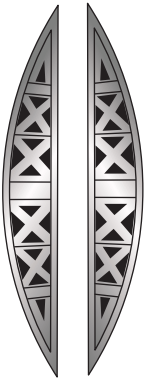

Curve this
segment

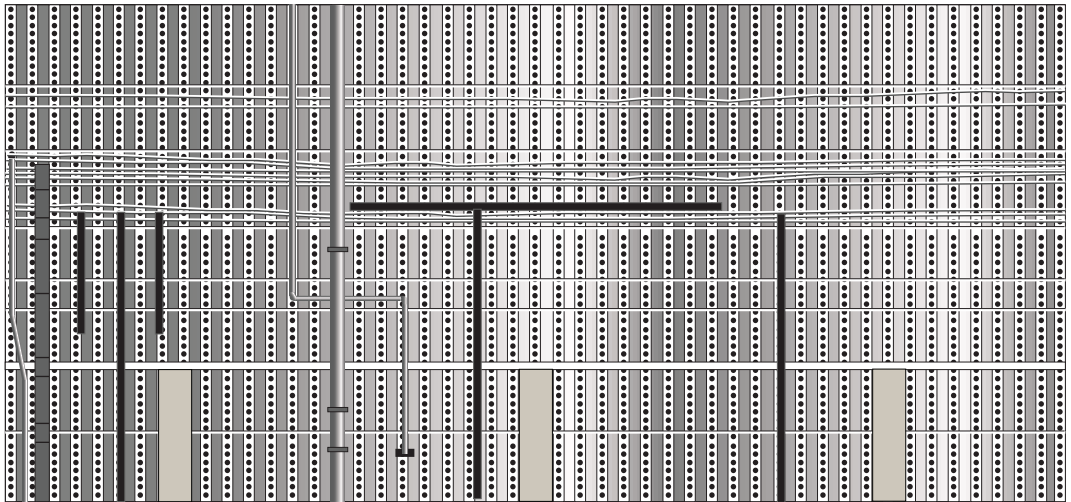
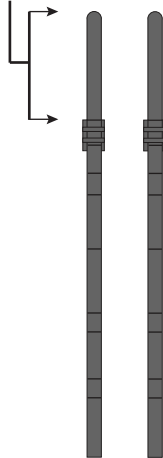
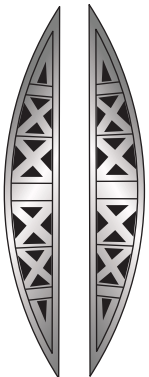



1 cm
1 inch

SpaceX Starship SN8

Print on Cardstock (110 lbs)

Revised after SN8 last video

COPVs

1:100 Scale

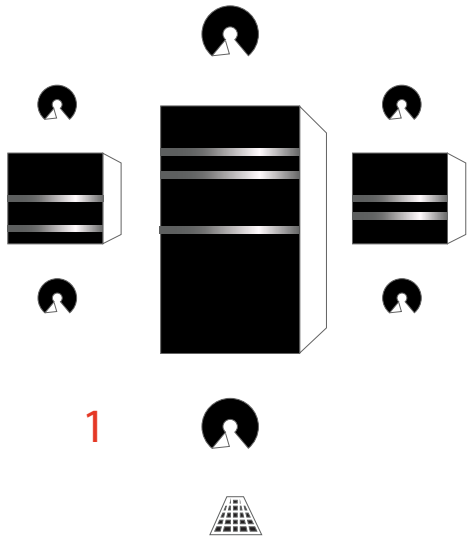

1

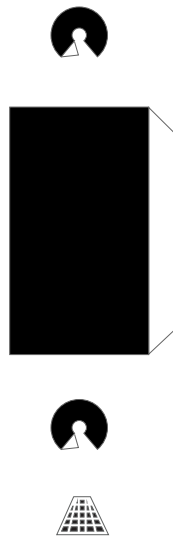

2

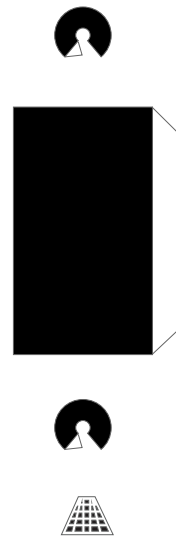

5

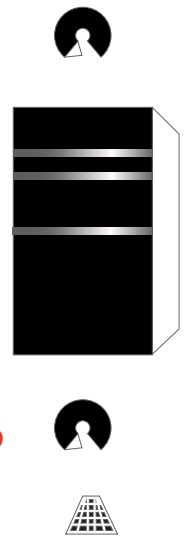

6

Tesla Battery #2

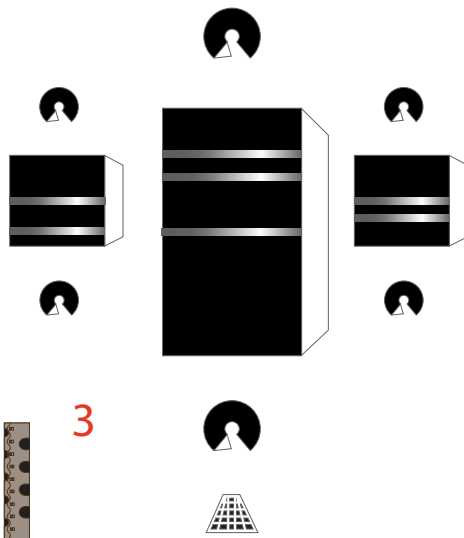

3

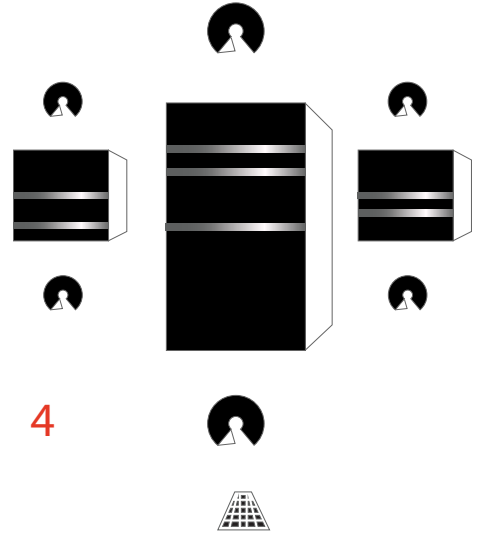

4

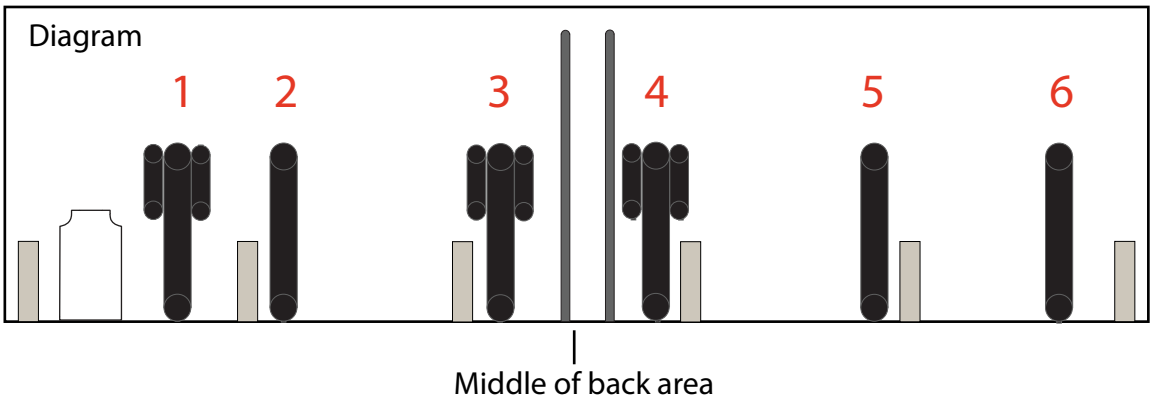
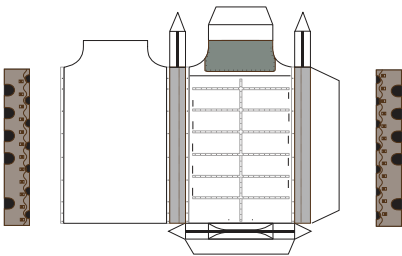

Use aluminum foil to cover all COPVs and Tesla battery.



1 cm

1 inch

1:100 Scale

SpaceX Starship SN-8

Print on Cardstock (110 lbs)

Landing Legs

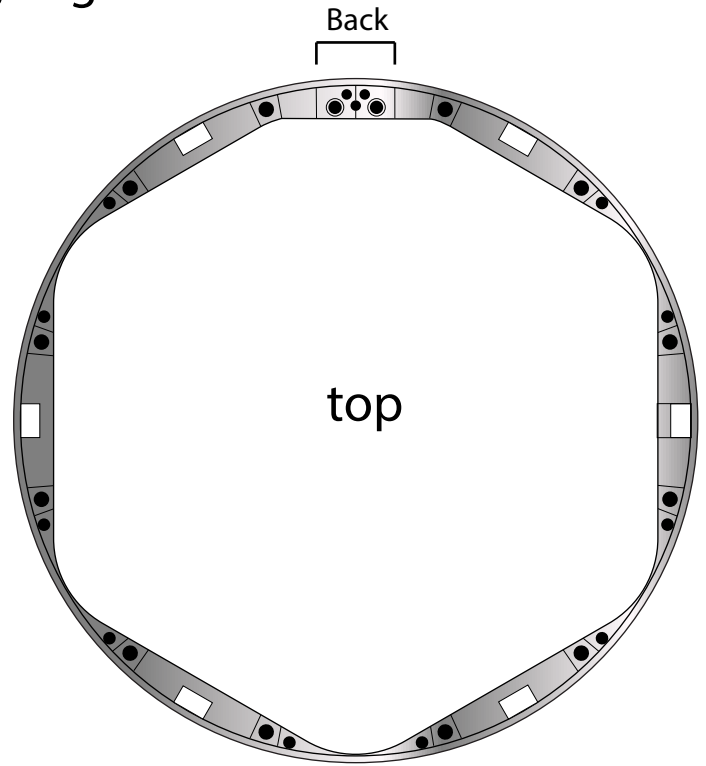
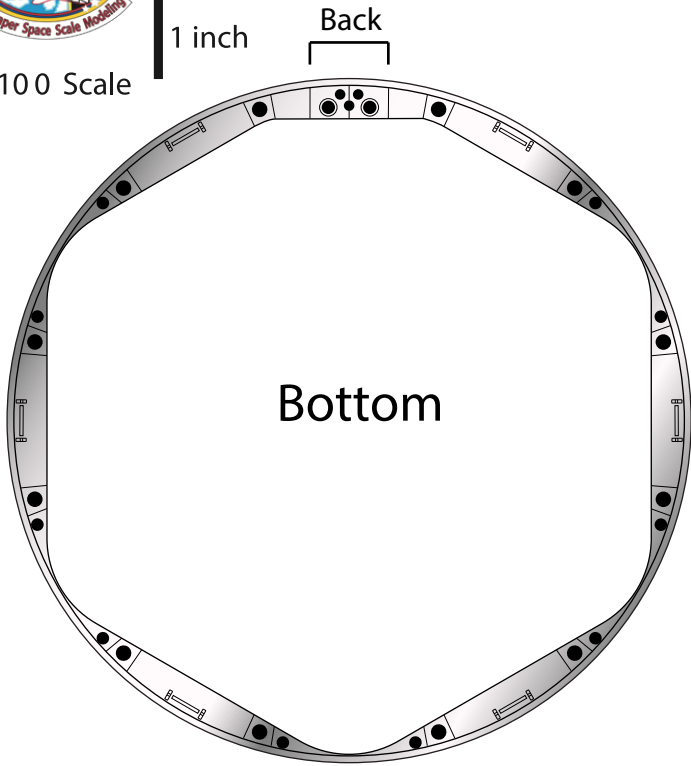

Leg support pillars

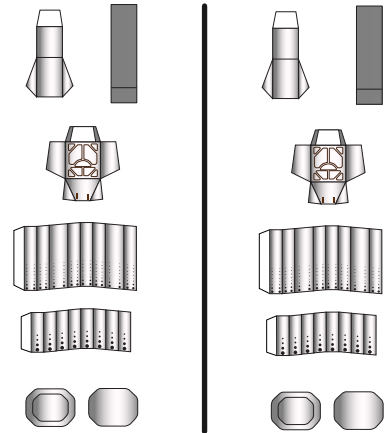
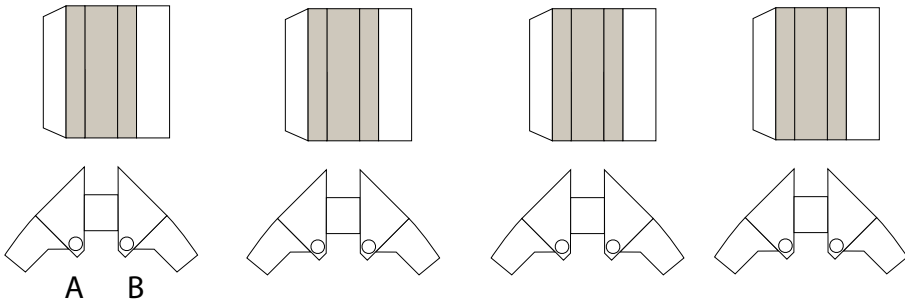

Landing Legs

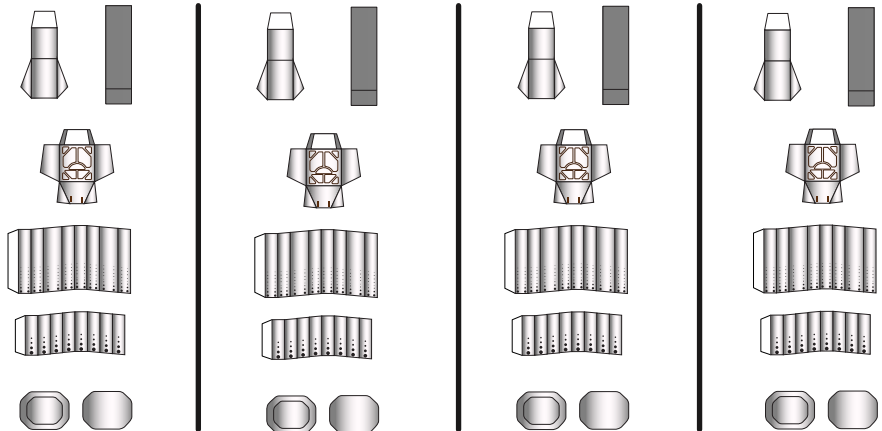
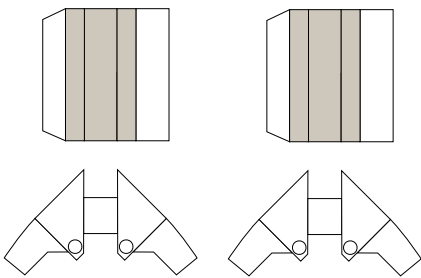

Use a cottonswab stick
(2 mm diameter) and cut 6
segments of 5 mm in length and
glue them between parts A and B.



1 cm

1 inch

1:100 Scale

Starship SN-8 Bulkhead

Print on Cardstock (110 lbs)

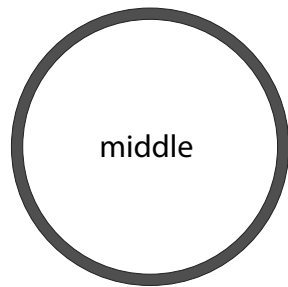
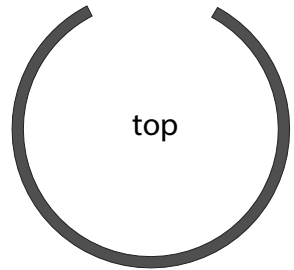
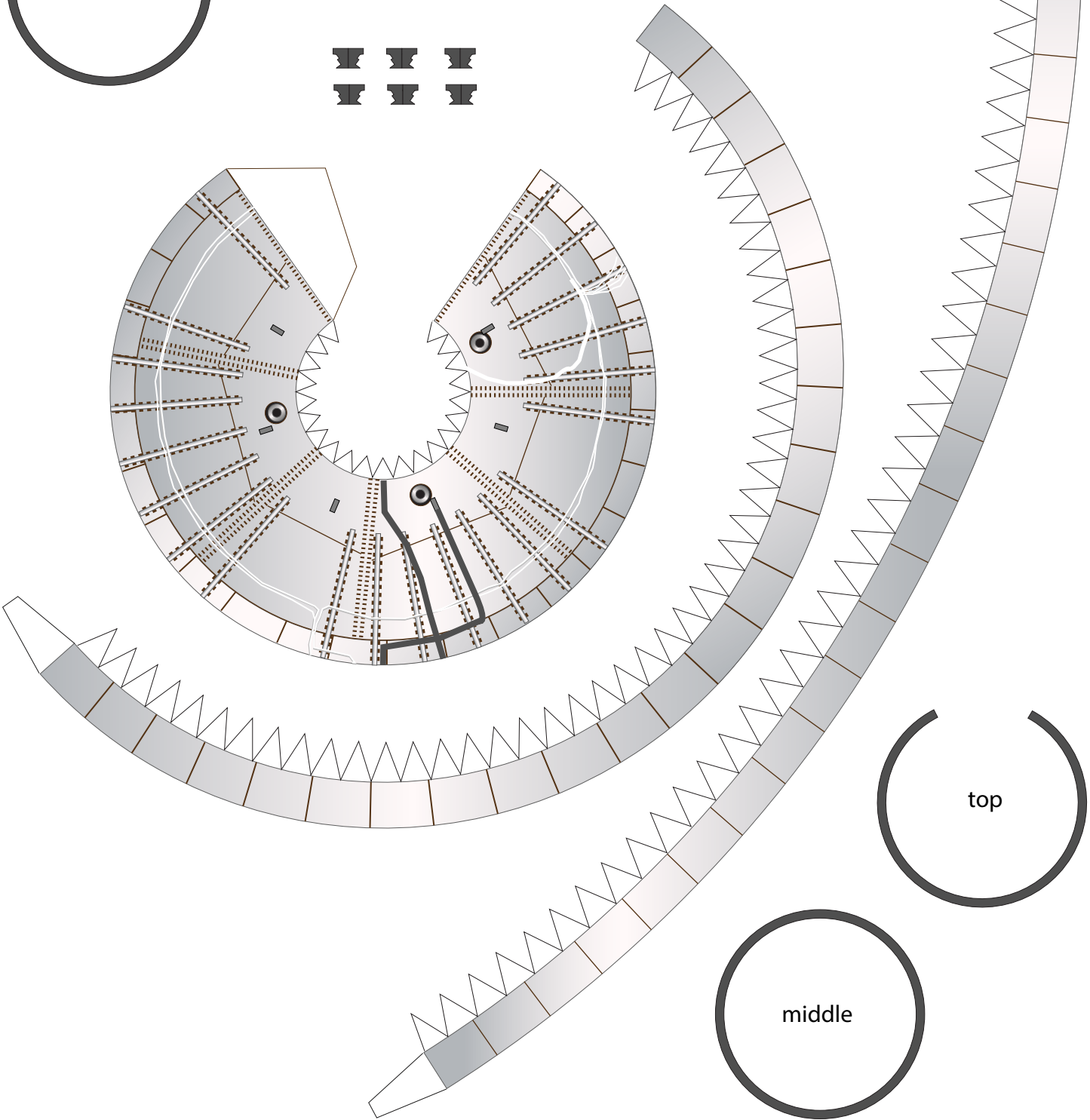
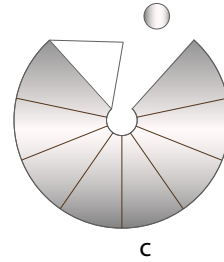
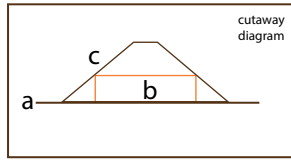
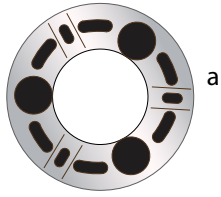
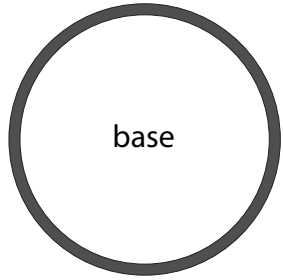



1 cm

1 inch

1:100 Scale

SpaceX Starship SN8

Print on Cardstock (110 lbs)

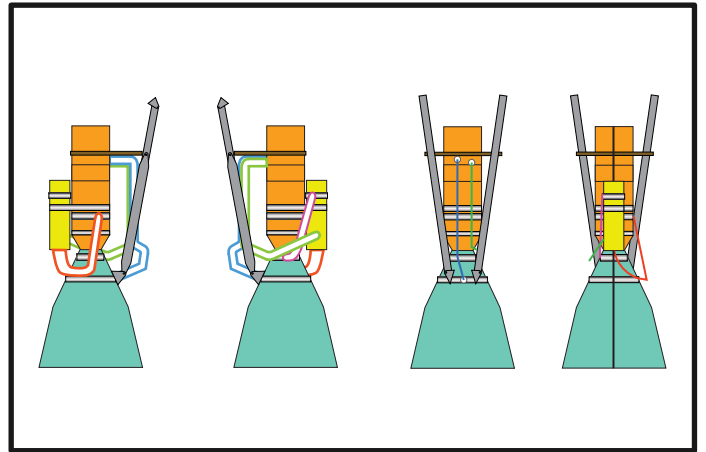
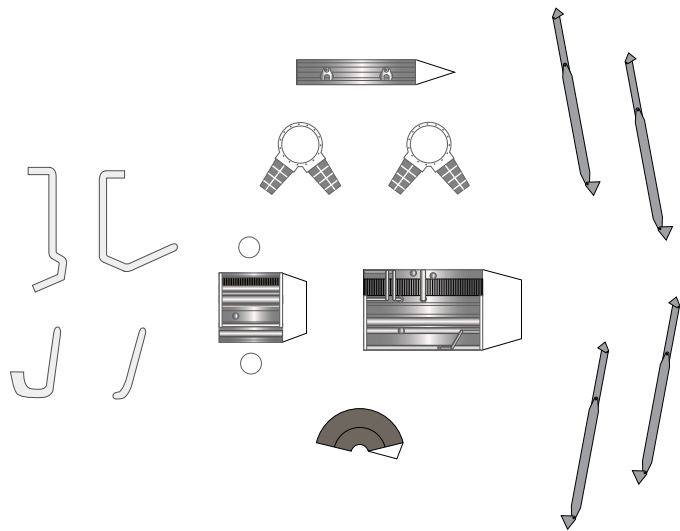
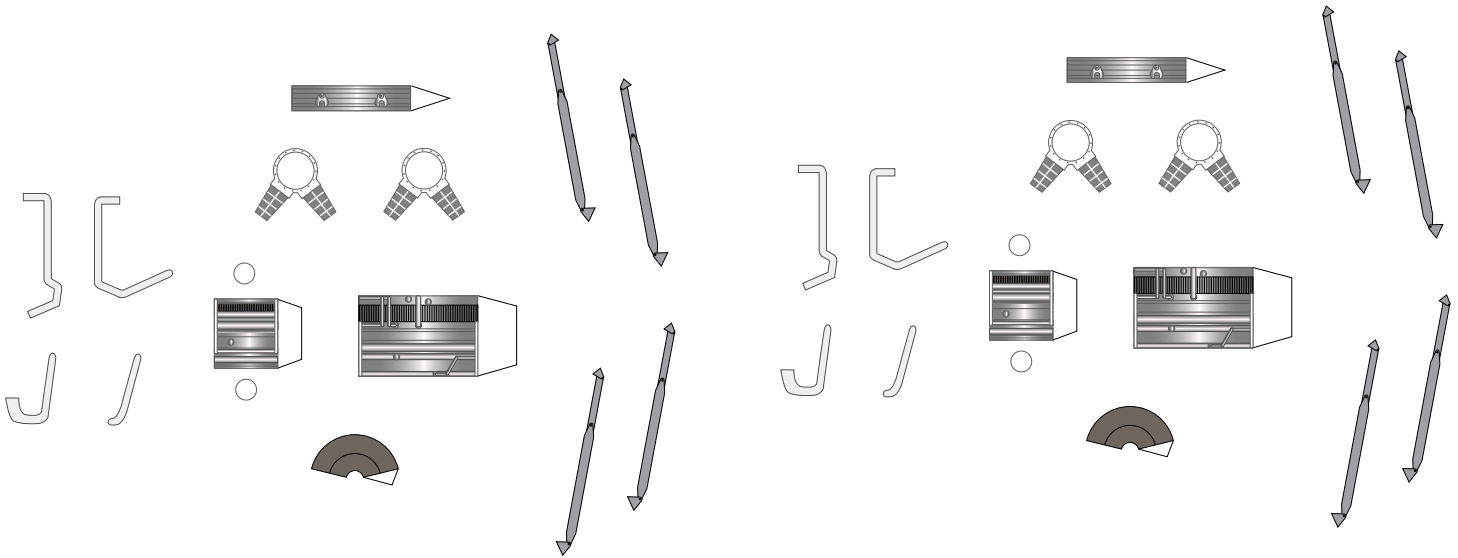
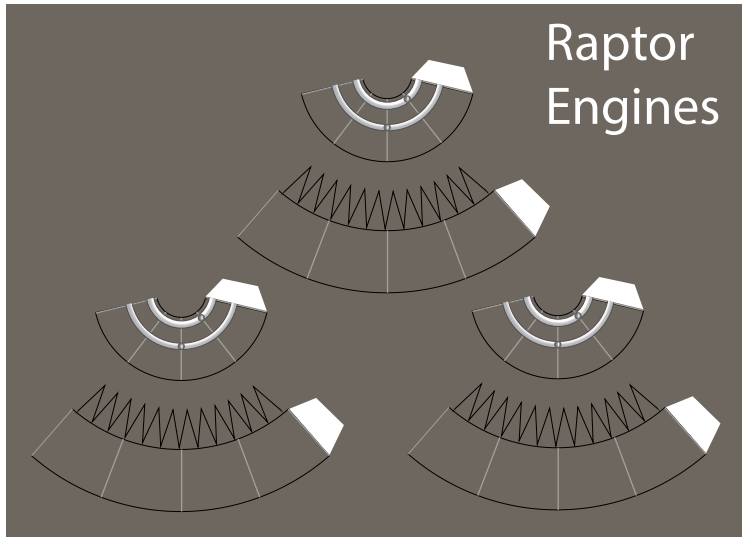





1 cm

1 inch

SpaceX Starship SN8

Print on Cardstock (110 lbs)

REFERENCE

NOT TO SCALE

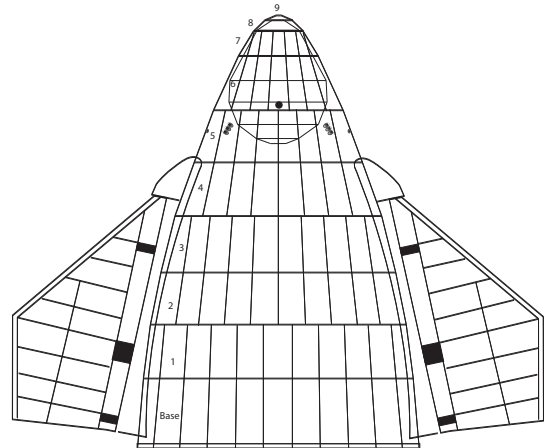
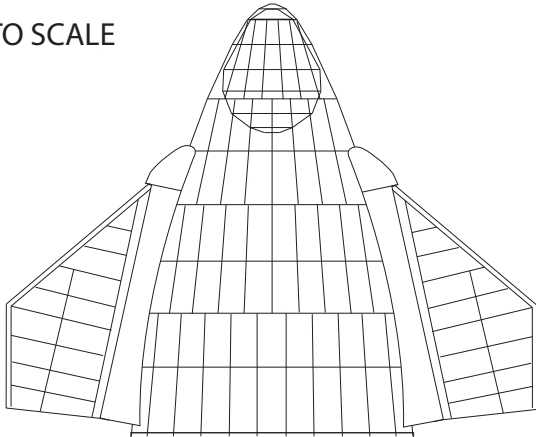

Umbilical side

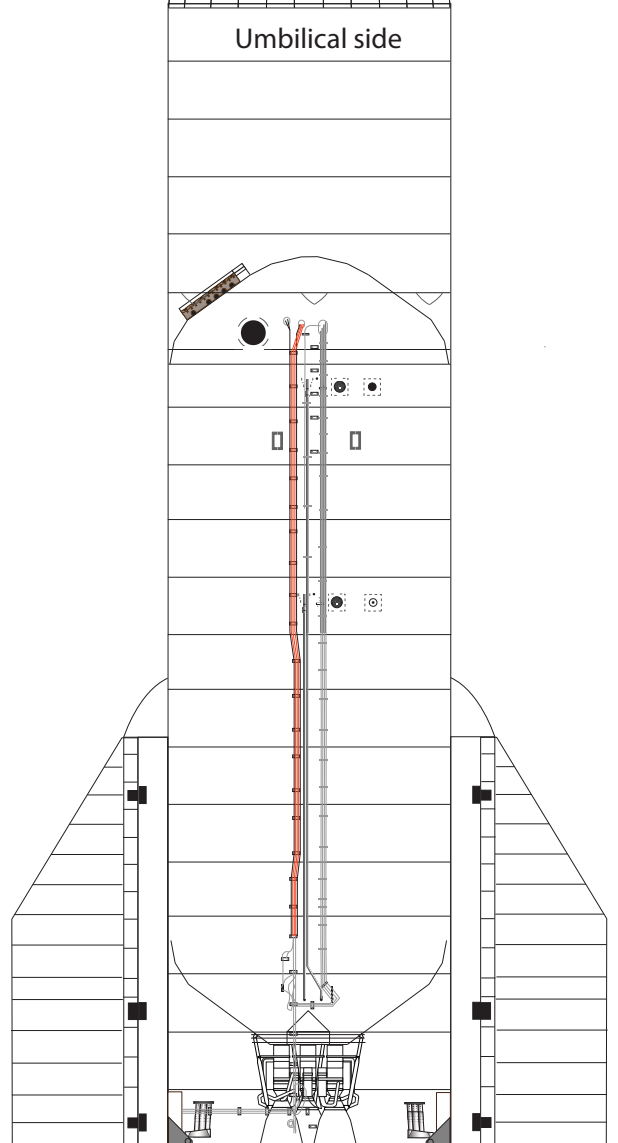
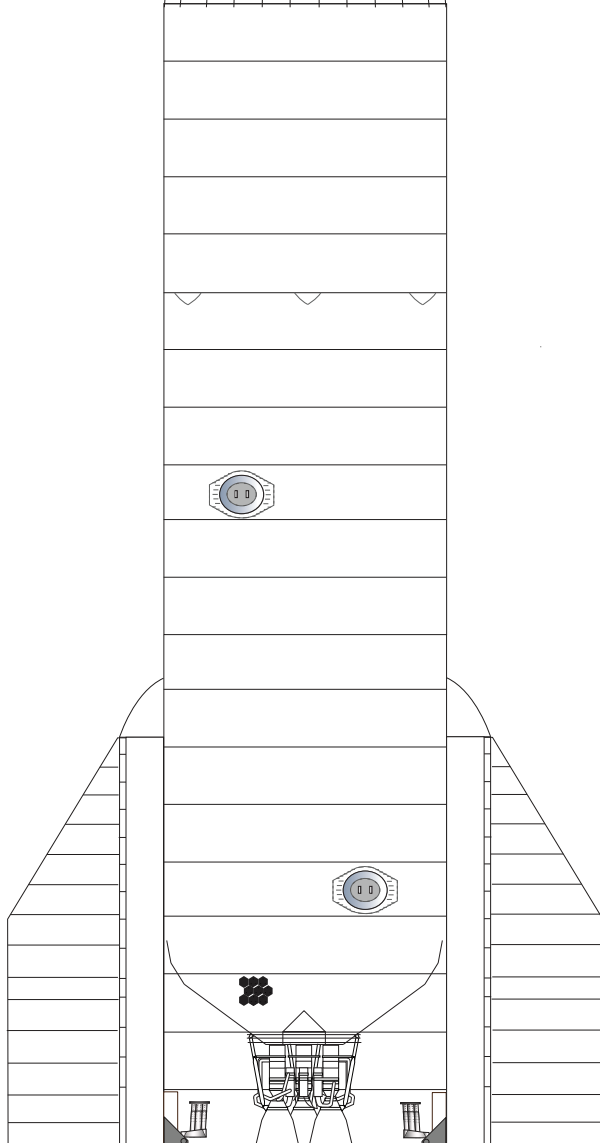

Front

Back